

Archaeology Wales

Tabernacle Church & Town Wall, Pembroke

Archaeological Evaluation



By
Philip Poucher

Report No. 1420

Archaeology Wales Limited,
Rhos Helyg, Cwm Belan,
Llanidloes, Powys SY18 6QF
Tel: +44 (0) 1686 440371
E-mail: admin@arch-wales.co.uk

Archaeology Wales

Tabernacle Church & Town Wall, Pembroke

Archaeological Evaluation

Prepared For: Pembroke 21C

Edited by: Mark Houliston

Signed: 

Position: Managing Director

Date: 16/12/15

Authorised by: Mark Houliston

Signed: 

Position: Managing Director

Date: 16/12/15

By
Philip Poucher

Report No: 1420

December 2015

Contents

Summary	1
1. Introduction	2
2. Site Description	3
3. Historical Background	4
4. Methodology	5
5. Results	6
5.1 Test Pit 1	6
5.2 Test Pit 2	7
5.3 Test Pit 3	8
5.4 Test Pit 4	9
5.5 Test Pit 5	10
5.6 Test Pit 6	10
5.7 Watching Brief	11
6. Finds	13
7. Discussion and Conclusion	17
8. Development impact	20
9. Bibliography	21

Appendix I – Finds register

Appendix II – Context register

Appendix III – Written Scheme of Investigation

Appendix IV – Archive Cover Sheet

List of Illustrations

Figure 1	Location map
Figure 2	Site boundary.
Figure 3	Trench plan
Figure 4	Test Pit 1 – plan & section
Figure 5	Test Pit 2 – plan & section
Figure 6	Test Pit 3 – plan & section
Figure 7	Test Pit 4 – plan & section
Figure 8	Test Pit 5 – plan & section
Figure 9	Test Pit 6 – plan & section

Figure 10 Trench plan overlaid on 1866 OS map

Photos

Photos 1 – 3	General shots of site
Photos 4 – 8	Test Pit 1
Photos 9 – 13	Test Pit 2
Photos 14 – 17	Test Pit 3
Photos 18 – 20	Test Pit 4
Photos 21 – 23	Test Pit 5
Photos 24 – 25	Test Pit 6
Photos 26 – 28	Garden terrace walling
Photos 29 – 30	Spoil heap prior to excavation
Photo 31 - 32	Spoil heap post excavation
Photos 33 - 34	Stairs in western boundary wall
Photos 35 – 38	Metallic finds

Copyright Notice:

Archaeology Wales Ltd. retain copyright of this report under the Copyright Designs and Patents Act 1988, and have granted a licence to Pembroke 21C Community Association to use and reproduce the material contained within.

The Ordnance Survey has granted Archaeology Wales Ltd a Copyright Licence (No. 100055111) to reproduce map information; Copyright remains otherwise with the Ordnance Survey.

Summary

In September 2015 Archaeology Wales Ltd (AW) carried out a trial pit evaluation within the rear burgage plot of the Tabernacle Church, Pembroke. Investigation of the site was commissioned by Pembroke 21C Community Association, as both part of the condition of a planning application (15/0239/PA) recommended by the Dyfed Archaeological Trust and as a community excavation designed to help inform the development proposals for 'The Journey Through Time', a project put forward by Pembroke 21C to use the site to tell the story of Pembroke's history through planting and interpretation panels.

The evaluation comprised the archaeological investigation of a total of 6 hand-excavated trial pits within the site. These trial pits were positioned to investigate possible features and areas of archaeological potential identified by a prior desk-based assessment of the site (Poucher 2015).

A medieval rock-cut gully was recorded in Test Pit 2, which may be associated with drainage connected to the initial expansion of Pembroke town along Main Street in the 12th/13th century. Residual pottery of a broad medieval date range was recovered from across the site, somewhat typical of regional medieval urban activity. No indication of the medieval town wall was recorded.

A similar spread of residual pottery from the 17th and 18th century was also recorded, recovered from locations across the site, including one possible demolition deposit recorded in Test Pit 4 that may indicate the presence of a 17th/18th century structure in the vicinity.

The majority of finds and activity identified came from the later post-medieval and modern periods. Extensive quarrying activity was noted, affecting the western part of the site. This appears to have originally predated the late-18th century, but may have continued into the early 19th century. A late 18th century limekiln is incorporated into the southern boundary wall of the site, the crucible of which was partially excavated in Test Pit 5. This suggested the kiln was out of use and being used as a rubbish dump by the mid to late 19th century. The northern edge of the crucible wall was identified, and internal facing stones appear to have been removed. A building was recorded along the northern edge of the site on maps of the 1860s. Elements of the boundary walls of this building were identified within and around Test Pit 1, which suggested both a relatively light-weight structure but also at least two phases of activity, both 18th/19th century in date. The structure appears to be semi-industrial in nature, but its precise function could not be ascertained. Garden soils intermixed with some late post-medieval demolition/construction material were noted along the garden terraces of the eastern half of the site, and a significant depth of late post-medieval deposits was also noted behind the southern boundary wall of the site.

Development proposals are unlikely to adversely affect any significant archaeological remains, with the exception of possible foundation work associated with stair access to the Tabernacle Church in the northeast corner of the site, which may affect remains of the post-medieval building identified in that area, and the proposed clearance of the limekiln crucible, which would require the removal of large amounts of material and renovation work on the internal wall face.

1 Introduction

- 1.1 This report has been prepared by Archaeology Wales Ltd (AW), in response to a request by Pembroke 21C Community Association, to provide an archaeological evaluation of the potential impacts of a proposed development within a garden plot behind the Tabernacle Church in Pembroke (Archaeology Wales Project Number 2319, site code TTWP/15/EV).
- 1.2 The proposed development plot occupies the rear burgage garden plot behind the Tabernacle Church in the centre of Pembroke, an area approximately 0.05ha, centred on SM 98695 01291 (Henceforth – the site), see figures 1 & 2. A planning application has been conditionally approved to turn this rear burgage plot area into ‘The Journey Through Time’, a garden designed to tell the story of Pembroke through planting and interpretation panels (planning application no. 15/0239/PA).
- 1.3 A previous archaeological desk-based assessment (DBA) of the development area was produced by Archaeology Wales (Poucher 2015) and a Building Recording report on the surrounding boundary walls is currently in production (Stafford & Poucher forthcoming). The desk-based assessment highlighted the general potential for prehistoric and early medieval archaeological remains, but more specifically medieval and post-medieval archaeological remains to exist on the site.
- 1.4 As a result of these findings, Dyfed Archaeological Trust Planning Services (DAT-PS), in its capacity as archaeological advisors to the local planning authority (Pembrokeshire County Council), recommended that an archaeological evaluation was undertaken in order to assess the potential for the archaeological resource at the site. The Pembroke 21C Community Association had also always intended to undertake an archaeological evaluation of the site, with community involvement, in order to better inform ‘The Journey Through Time’ project.
- 1.5 A Written Scheme of Investigation for the archaeological evaluation was produced by Archaeology Wales and approved by DAT-PS (see Appendix III). The subsequent evaluation used six strategically placed test pits designed to determine if any of the features or areas identified by the DBA were of archaeological importance. One further pit was planned, but due to a considerable overburden of modern material it was not possible to pursue it. This area of modern overburden was subsequently reduced and spread across the site, work which was undertaken under archaeological watching brief conditions; the results of are included within this report. Following a site monitoring visit by DAT-PS, it was recommended that one of the test pits was extended. However, due largely to health and safety considerations, planned work in this area was halted and development proposals altered, and consequently no further excavation has taken place. The evaluation work was designed to elucidate the presence or absence of archaeological material, its character, distribution, extent, condition and relative significance. The test pits were largely focused on areas where there was considered to be the greatest potential for archaeological activity. This report details the findings from all the test pits within the site area.

- 1.6 The excavations took place in September 2015. The work was managed by Phil Poucher and carried out under the supervision of Andrew Shobbrook.
- 1.7 All work conformed to the ClfA's Standards and Guidance for Archaeological Field Evaluation (2014).

2 Site description

- 2.1 The site comprises the rear garden burgage plot to the Tabernacle Church in Pembroke (NGR SM 98695 01291). The Church itself fronts Main Street (the A4139) in the centre of Pembroke town, although access to the rear garden plot is currently via a gateway opening on to Common Road to the south.
- 2.2 There is a significant drop in levels between Main Street to the north and Common Road to the south. The Church sits at a level c.4.5m above the garden plot site to its south, with the two separated by a tall wall set on a vertical rock-cut face.
- 2.3 The garden plot site is largely on two main levels. The upper level consists of a ledge c.6.5m wide, running the full width of the plot at its northern end. The lower level is set roughly 6m below that. The eastern half of the garden plot is terraced down between the two main levels in a series of slopes, while the western half drops down in a series of vertical rock faces. The site is bounded to the north by the walled face below the Church and to the east and west by high stone-built walls separating the adjoining garden plots. To the south it is bounded by a stone-built wall incorporating the remains of an 18th/19th century limekiln. Within the garden site lies a small cave set back eastwards underneath the sloping terraced eastern side of the plot.
- 2.4 The historic core of Pembroke town, which includes this site, is laid out along a roughly east – west orientated ridge of Carboniferous limestone, with the Pembroke River running along its northern edge, and an area of former marshland to the south. The marshland is now largely reclaimed and lies partly as open ground and partly under car parks. The large medieval castle dominates the western end of the ridge.
- 2.5 The limestone ridge forms part of the Pembroke Limestone Group. The lower-lying ground a short distance to the south of the site is overlaid with alluvial deposits of clay, silt, sand and gravels laid down when the limestone ridge was formerly surrounded on both sides by rivers (Howells n. d. & BGS 2015).

3 Historical Background

- 3.1 A previous archaeological Desk-Based Assessment has been undertaken (Poucher 2015) and a detailed history of the site is included in that report. This information can be summarised as follows.
- 3.2 Important Prehistoric and Mesolithic remains have been recovered from caves within the limestone bedrock prevalent in the area. One cave is located on the site, which highlights the potential for similar remains within the site area. However, the cave itself appears to have been disturbed through later quarrying activity and it was not possible to investigate any internal cave deposits due to the possible presence of roosting bats.
- 3.3 There is also a general potential relating to inferred Iron Age and early medieval activity on the limestone ridge upon which Pembroke is located. It is possible Pembroke castle is sited on the location of an Iron Age defended enclosure. This may also have been the location of a regional administrative centre during the early medieval period.
- 3.4 The main potential of the site, however, was seen as likely to be medieval and post-medieval in origin. The site occupies what appear to be two or three combined medieval burgage plots that are likely to have been laid out in the 13th century, in an area that was enclosed by defensive town walls in the late 13th/early 14th century. The line of the medieval town wall is believed to follow the line of the extant wall forming the southern boundary of the site, although no medieval fabric survives in that stretch of wall. It is tentatively suggested that the east-west aligned ridgeline within the site would have provided a more naturally defensive location for the town wall, but this does not currently align with other section of medieval walling recorded to the east.
- 3.5 Little is known of the subsequent use of the site, although part of it appears to have been quarried and a limekiln was incorporated into the southern boundary, possibly in the late 18th century. The first detailed maps of the 1860s depict the limekiln, but do not label it. They do, however, show a building situated on the ridge along the northern edge of the site, which was interpreted as possibly semi-industrial in nature, given its location close to the quarried rock face and limekiln, and the knowledge that two of the three burgage plots immediately to the north were occupied by a wheelwright and a cobbler. This building is not shown on subsequent maps. A second small building is also shown in the northeast corner of the site in the 1860s and appears to correspond to the location of the stone-built outhouse that still stands there.
- 3.6 The site was purchased and the Tabernacle Church was built in 1867/8. From that period onwards there is no specific recorded use of the rear garden plot. In 1878, the adjacent plot to the east was purchased for the construction of a manse associated with the site. Presumably at some point after this, access through the adjoining boundary wall was created, both into the outhouse in the northeast corner and

further to the south, to link the adjoining garden plots. There has been no known development or recorded activity within the site in living memory

4 Methodology

- 4.1 Prior to the start of the evaluation, a Written Scheme of Investigation was produced detailing the methodology for the archaeological evaluation. This was agreed by DAT-PS and a copy is included in Appendix III. The agreed evaluation was for seven test pits to be excavated within the site. In the event one test pit was located in an area with a substantial depth of modern overburden and therefore this location was abandoned. The trenches were positioned to maximise the retrieval of archaeological information identified by the desk-based assessment and to ensure that the archaeological resource was understood.
- 4.2 The location and orientation of the test pits are illustrated in the accompanying figures. The dimensions of the trenches are described in the results below.
- 4.3 The test pits were all excavated by hand. The trenches were excavated to the top of identified archaeological deposits, the natural soil horizon or to the maximum safe depth.
- 4.4 All areas were hand cleaned to prove the presence, or absence, of archaeological features and to determine their significance. Sample excavation was undertaken on all of the identified archaeological features. Recording was carried out using Archaeology Wales recording systems (pro-forma context sheets etc.), using a continuous number sequence for all contexts.
- 4.5 Written, drawn and photographic records of an appropriate level of detail were maintained throughout the course of the project. Digital photographs were taken using cameras with resolutions of 5 mega pixels or above.
- 4.6 Plans and sections were drawn to a scale of 1:50, 1:20 and 1:10 as required, see Figures 4 - 9.
- 4.7 The fieldwork was undertaken in September/October 2015. A site monitoring visit was undertaken by a representative of DAT-PS on 7th October 2015, prior to the backfilling of any excavated areas.

5 Results

5.1 Trench 1 (1.2m x 1.2m, Figure 4, Photos 4 - 8)

- 5.1.1 The test pit was located on a raised ledge at the northern end of the site. This ledge measured c.6.5m wide, extending across the width of the site, and was located roughly 4.5m below the level of the Chapel to the north, and c.6m above the lowest level of the southern edge of the site. It was located to investigate the site of a building visible on Ordnance Survey maps of the 1860s (see Figure 10). A short vertical drop in ground levels midway along the ridge was assumed to represent the eastern gable wall of this structure. Preliminary clearance work around this area revealed mortared masonry lying directly on top of a small quarried rock ledge. The approximate footprint of the building was visible as a lowered platform within the ledge. It is possible the opposing gable wall is represented by a return in the western boundary wall of the site, although the Ordnance Survey map suggests the building is separate to the boundary wall. The test pit was located centrally within this platform in the hope of picking up floor deposits.
- 5.1.2 Bedrock was exposed within a sondage cut against the eastern side of the test pit, at a depth of 0.72m to 0.9m below current ground levels (11.17mOD). The bedrock was stepped slightly but appears largely to present a level surface, possibly representing part of an artificially created terrace into the bedrock. There is, however, no indication that the bedrock itself was used as a surface.
- 5.1.3 Overlying the bedrock was a compact layer of greyish-brown sandy-silt (deposit 106) with frequent mortar flecks apparent throughout. This deposit was at most 0.21m thick, with the revealed upper surface relatively level throughout. Two sherds of pottery were recovered from this deposit, broadly dateable to between the late 18th and early 20th century, along with some small fragments of late post-medieval clay pipe. This deposit may have been laid as a levelling deposit, possibly trampled flat and used as a surface at 11.2mOD.
- 5.1.4 Cut into deposit 106 was a shallow-cut feature (cut 105) with a flat base and straight edges, appearing possibly square or rectangular in plan. This feature was filled with a crumbly orangey-brown, heat-affected, clayey-sand with frequent flecks of coal throughout (deposit 104). The heating did not occur *in situ*, and the deposit would appear to be dumped waste material from an oven or fire, possibly indicating some form of industrial or semi-industrial activity in the vicinity.
- 5.1.5 Overlying these features was a thick (up to 0.35m) deposit of mid reddish-brown clayey-silt (deposit 102), containing large amounts of fragmented stone, along with some mortar and coal fragments. The top of the deposit was level, suggesting it may have been imported or spread across the area as a levelling deposit.
- 5.1.6 Two features appear to have subsequently been cut into deposit 102. In the northwest corner of the test pit, structure 103 appears to have cut the deposit, although the relationship is uncertain due to both the limited area revealed and the disturbed

nature of the structural remains. Structure 103 consisted of several large undressed blocks of limestone, bonded in a light brown-grey lime mortar. The mortar had been thickly adhered, but does not appear to form a strong bond. The mortared stonework protruded from both the northern and western sections and may have formed either the angled corner of a structure or a curved piece of walling, although some stones appear to have been removed. The stones lay 0.45m below current ground levels, at 11.8mOD. To the northwest, on what may be the interior of the structure, a deposit of reddish-orange clayey-sand (deposit 110) with frequent flecks of coal lay against and on top of some of the stone forming structure 103. This deposit was clearly heat-affected and may be the result of some form of industrial activity. It is strikingly similar in composition to deposit 104, although stratigraphically would appear to have been deposited (or re-deposited) at a later period. Towards the base of the deposit was a single sherd of 19th-20th century pottery that was clearly not heat-affected, which would suggest this is a dumped deposit rather than being burnt *in situ*. The top of both structure 103 and deposit 110 appears to have been disturbed, as a mixed deposit of stone, crushed mortar and reddish-orange clayey-sand (deposit 118), up to 0.12m thick, overlay both 103 and 110, and partly spread across deposit 102. The composition of this deposit appears to be a mix of 103 and 110.

- 5.1.7 Along the southern edge of the test pit the slight remains of a wall (wall 101) were revealed, 0.2m below current ground levels at 11.65mOD, cut into deposit 102. This wall was 0.28m wide and ran the width of the test pit in an east – west direction, broadly parallel to the rear wall of the site, and was contained within a close-fitting construction cut (cut 109). The remains consisted of several large blocks of unworked limestone set in a hard light pinkish-grey lime mortar with coal flecks throughout. The dimensions of the wall indicate that these are not the remains of a substantial structure, and may have functioned as the foundations for a light relatively-temporary structure or internal walling.
- 5.1.8 The test pit revealed a covering topsoil layer (deposit 100) of stony, dark grey-brown sandy silt that was currently very biologically active with many small roots present. This deposit was typically 0.3m thick.

5.2 Trench 2 (1.2m x 1.2m, Figure 5, Photos 9 - 13)

- 5.2.1 This test pit was located towards the northeast corner of the site, in a raised area at the northern end of a series of garden terraces that run down the eastern half of the site. It was located to investigate an area where both possible garden deposits may have improved preservation, but also where modern service trenches may exist, and in a possible alternative location for a medieval town wall.
- 5.2.2 Bedrock deposits were revealed at depths of between 0.5m and 0.9m below current ground levels (11.93mOD). The bedrock of solid limestone appeared to be stepped along the eastern side of the test pit, with the steps running in a north – south direction. A linear cut into the bedrock (cut 131) was revealed on the western side of

the test pit, with a straight, vertical, eastern edge also running in a north – south direction. The western edge was not revealed but the linear feature was at least 0.45m wide and 0.35m deep. The base of the feature sloped gently down to the south and was somewhat irregular but generally slightly concave in profile. The profile and direction of slope would suggest a drainage gully.

- 5.2.3 This gully (cut 131) was covered by a thick (up to 0.4m) deposit of dark brown silty-clay (deposit 130) that both infilled the feature and covered the bedrock steps to the east with up to 0.12m of soil in places. There was no indication of individual layers within this deposit, which also contained much root disturbance. It appears to represent a thick deposit of garden soil or abandonment. Several fragments of pottery were recovered from the deposit, which comprise Minety-type ware dateable to anytime between the early 12th century and the 15th century, and Ham Green ware, dateable between the mid-12th and 13th centuries.
- 5.2.4 Overlying deposit 130 was a 0.12m thick layer of dark-grey sandy-silty-clay with abundant fragments of lime mortar (deposit 129). The mortar inclusions suggest this deposit may represent demolition material or construction waste. It begins to thin out to the west, suggesting it was dumped from the east, in which direction lies the boundary wall of the plot. A number of fragments of late post-medieval pottery was recovered from this deposit, as well as several fragments of pottery that can be dated to the mid to late medieval period, which are presumably therefore residual. Oyster shells were also recovered from this deposit.
- 5.2.5 The topsoil (deposit 133) consisted of between 0.2m and 0.4m of dark grey-brown garden soils, heavily root disturbed.

5.3 Trench 3 (1.2m x 1.2m, Figure 6, Photos 14 - 17)

- 5.3.1 This test pit was located within a garden terrace mid-way down the eastern half of the site. It was located to investigate these garden terraces and also in an area where garden deposits may result in improved preservation of potential archaeological features.
- 5.3.2 Solid limestone bedrock was reached at a depth of between 0.8m and 0.6m below ground levels (8.64mOD). The bedrock itself was uneven but generally level, the changing depth from ground level accounted for by the slope in the current ground surface.
- 5.3.3 Overlying the bedrock was a 0.4m to 0.26m thick deposit of very stony, light brown sandy-silt (deposit 127). No dateable finds were recovered, but small fragments of coal, oyster shell and animal bone were noted. Coal fragments and oyster shell are typical of later post-medieval deposits, although both would also have been available during the medieval period. This deposit exhibited a slope from north to south, mirroring the current ground levels, although the high frequency of large stone inclusions may suggest this acted as temporary working surface or waste building material.

- 5.3.4 Overlying this deposit was 0.2m of a mid grey-brown clayey-silt (deposit 126), which contained abundant stone inclusions along with some coal fragments and oyster shells. Several fragments of pottery were recovered from this deposit, which include late post-medieval pottery along with some residual medieval pottery of the 13th to 15th centuries. Late post-medieval animal bone was also recovered.
- 5.3.5 The topsoil (deposit 125) consisted of 0.2m of dark grey-brown clayey-silt garden soil, heavily root disturbed.

5.4 Trench 4 (1.5m x 1.5m, Figure 7, Photos 18 - 20)

- 5.4.1 The test pit was located towards the southeast corner of the site. The trench was located to investigate a relatively open area, with potentially deep deposits close to the southern edge and presumed line of the medieval town wall.
- 5.4.2 The trench was excavated to a maximum safe depth of 1.2m (6.56mOD). At this depth a layer of compacted, stony, light reddish-brown clayey-silt (deposit 115) was partially revealed. The layer was unexcavated, but the compacted nature of the deposit may indicate it functioned as a surface. Fragments of coal and ceramic building material were noted within the surface of this deposit, suggesting a later post-medieval date. Against the western section of the test pit a possible post hole (cut 116) cut through this layer. Semi-circular in plan, although it was not possible to excavate the feature further to confirm, it represented a cut feature. The infilling material was a moderately compacted, mid-brown silty-clay (deposit 117).
- 5.4.3 Overlying deposit 115 was a 0.3m to 0.4m thick deposit of mid to dark brown silty-clay (deposit 114), containing occasional fragment of coal and mortar. Within this deposit were fragments of pottery dateable to anytime between the 18th and early 20th century, although it also included a few fragments of residual medieval pottery, along with some animal bone and oyster shell. Up to 0.12m of a mid pinkish-brown clayey-silt (deposit 113) overlay this, again containing fragments of coal and mortar and potentially representing a dumped building demolition or construction deposit. Fragments of both general medieval and later post-medieval pottery were recovered from this deposit. Above this was a thick (0.4m) deposit of mid-brown silty-clay (deposit 112), containing some fragments of mortar and coal, along with some mid to late medieval and later post-medieval pottery and animal bone.
- 5.4.4 These layers were topped with 0.2m to 0.28m of dark brown garden soil (deposit 111), also containing some medieval, but largely later post-medieval, pottery fragments.

5.5 Trench 5 (2.4m x 1.2m, Figure 8, Photos 21 - 23)

- 5.5.1 This test pit was an elongated trench excavated on the site of a 18th/19th century limekiln on the southern edge of the site, located primarily to investigate the internal structure and infilling material within the crucible of the kiln.
- 5.5.2 The trench was excavated to a maximum safe depth of 1.1m. The rear wall (wall 119) of the crucible was revealed 0.2m below current ground levels (6.42mOD). The trench was subsequently extended northwards which revealed the upper part of the wall to be 0.4m wide. The internal face of the wall was revealed to a depth of 1m, sloping steeply towards the centre and with a slight curve indicating the circular nature of the limekiln crucible. The wall was constructed from large blocks of unworked, multi-faceted limestone, well sorted for size and bonded in a pinkish-cream lime mortar. Both mortar and some internal stone faces show signs of being heat-affected. The internal face however is very rough, and evidence of heating appears relatively light considering the use of the limekiln crucible, it is likely therefore that internal facing stones have been removed leaving the rough core of wall behind.
- 5.5.3 To the rear of the wall was a deposit of loose limestone in a light brown sandy-silt (deposit 135). This deposit was not excavated or examined closely, but may represent a spread of quarried limestone ready for the limekiln, or waste from loading the kiln, or alternatively it could be waste limestone used as a levelling and buttressing deposit to the rear of the wall.
- 5.5.4 Within the crucible of the kiln only two deposits were identified. The lower deposit consisted of a loose, mid-brown, silty-clay (deposit 121) with frequent stone inclusions, along with fragments of slate, lime mortar, coal and discrete patches of wet clay. This deposit was not bottomed, but was at least 0.8m thick and clearly represents dumped soil and waste material used to infill the centre of the crucible. Overlying this was a 0.55m thick deposit of more finely sorted, mid-brown, clayey-silt (deposit 120) with fewer stones and some coal and mortar fragments. Both deposit 120 and 121 contained a significant quantity of pottery fragments, dating from the medieval through to the later post-medieval periods, along with late post-medieval glass, animal bones, oyster shells and several unidentified metallic objects of late post-medieval or early modern date. Both deposits had also clearly been dumped to infill the crucible up to the surviving level of the wall to the rear.
- 5.5.5 Overlying these layers was between 0.15m to 0.2m of topsoil.

5.6 Trench 6 (1.2m x 1.2m, Figure 9, Photos 24 - 25)

- 5.6.1 This test pit was initially located to investigate deposits to the rear of the limekiln structure, however, for reasons of practical site access and safety this was relocated to the southwest corner of the development area to investigate deposits at the lowest point of the site.

- 5.6.2 This trench was only excavated to a depth of 0.35m, which revealed a layer of compact light orange-brown clay with abundant large stone inclusions (deposit 124). Excavation ceased at this level as it was initially thought to represent a level surface. The high stone content suggests, however, that it is more likely to represent a levelling or foundation deposit.
- 5.6.3 Overlying this was a 0.15m thick deposit of stony, semi-compacted dark grey-brown clayey-silt (deposit 123), which contained fragments of 19th to early 20th century pottery and glass. This deposit had a relatively flat and compacted surface, suggesting a possible rough working surface or trampled layer. This was covered by 0.2m to 0.25m of topsoil (deposit 122).

5.7 Watching Brief (Photos 26 – 38)

- 5.7.1 The removal of some tree stumps and a large spoil heap of modern origin on the site was carried out under archaeological observation. The work was undertaken using a mini-digger to both dislodge and uproot the tree stumps and to reduce the spoil heap and spread it out over the lower western part of the site, thereby raising ground levels in that area.
- 5.7.2 The tree stumps were removed in the area of the lower garden terraces along the eastern side of the site, in relatively close proximity to Test Pit 3. The removal of the stumps revealed root disturbed garden soils that appeared to correspond to deposit 125, and variations in the soil were not visible due to the heavy root disturbance. Further detail on the low terrace walls that define the garden terraces were revealed however. Both walls were constructed of roughly-dressed limestone blocks, well-sorted for size, and with the occasional brick inclusion suggesting a later post-medieval date. They appeared to be largely of a dry-stone construction although lime mortar was noted in places. Occasionally this lime mortar, which included coal fragments, adhered to the face of some of the stones suggesting they were re-used stones. The mortar was similar in colour and composition to the nearby boundary wall to the east. Both walls appeared to only have shallow foundations into the topsoil, although this was not confirmed through excavation. A southward return, 0.4m long, was recorded in the northern of the two terrace walls, at its eastern end, leaving a gap of 0.8m between the return and the boundary wall. This would suggest the route of a footpath along the inside face of the boundary wall. No indication of steps were revealed, although a large dislodged concrete block was noted in this area that may have formed part of some former steps. A similar arrangement, complete with steps, was noted within the adjoining plot to the east, and built against the eastern face of the boundary wall.
- 5.7.3 The spoil heap was built up on the lower ground against the western boundary wall of the site. It was located directly underneath a collapsed section of the boundary wall which would suggest it largely originated from clearance works in the neighbouring plot to the west. Elements of the spoil heap may also have originated from waste

tumbled down from an overhanging brick-built outhouse to the Church on the ledge to the north. The loose nature of the surface of the spoil would suggest it was a modern deposition.

- 5.7.4 The spoil heap was excavated up to the western boundary wall to a depth of 1.5m, and was spread across the lower western part of the site. Stonework was removed for re-use in wall restoration, and finds were also retained. No stratification in the spoil heap was noted but it did appear to comprise a mix of collapsed walling and dumped material (deposit 150).
- 5.7.5 A large number of finds were recovered from this deposit, including pottery, glassware, metalwork, animal bone and plastic items. Many items were clearly modern, and could be dated up to the later 20th century, these were discarded. The pottery included a range of ceramics dateable to between the 18th and 20th centuries. The glassware was also from a similar period, and included a number of complete bottles of late 19th to 20th century date. The metalwork also ranged from 19th to 20th century material, and included ornamental railing decorations, an early to mid-20th century gin trap and an unusual steam-ship chair base from the earlier 20th century.
- 5.7.6 Clearance works next to the boundary wall also revealed a series of steep stone steps situated along the inner face of the wall. The steps were 0.83m wide, between 0.1m and 0.2m deep and between 0.15m and 0.2m high. They were built of large dressed stone blocks, bonded together in a light grey lime mortar. The steps butted against the western boundary wall, and were encased on their eastern side with a mortared stone wall 0.5m thick, built of roughly faced limestone blocks bonded in a cream-coloured lime mortar with coal inclusions, in a similar style to the western boundary wall.
- 5.7.7 The steps gave access from the ledge across the northern end of the site, and aligned with the end of a 3.6m long return in the western boundary wall located at this upper level. The upper part of the steps had been disturbed through root action, and a brown-glazed ceramic drainage pipe had been laid along the surface of the steps. The lower part of the steps appeared to have either collapsed or been truncated, although further remains may lie buried beneath current ground levels.

6 Finds (Appendix I)

6.1 Ceramics

- 6.1.1 A large quantity of ceramics (433 sherds) were recovered both from the test pits and subsequent watching brief. These finds are listed and identified in Appendix II, those that were not readily identifiable were submitted for specialist analysis and this report is also included within Appendix I. The ceramics produced the earliest dateable material on the site. The medieval pottery came from jugs and bowls, typical of urban domestic assemblages from this region. The post-medieval pottery came from a variety of jugs, bowls, plates and other items, again typical of domestic assemblages and urban settings.
- 6.1.2 Within **Test Pit 1**, deposit 107, which is a continuation of deposit 106, contained three fragments of pottery, one earthenware piece dated to between the 17th and 18th centuries and the other two consisting of earthenware and china broadly dateable to anytime between the 18th and early 20th century. Taken together they date the deposit to anytime between the 18th and early 20th century, possibly focusing on the earlier part of that period. This layer was the earliest dated stratigraphic layer within the test pit, and corresponded to a possible surface overlying the bedrock.
- 6.1.3 From within deposit 102 came two fragments of Ham Green Ware jug, dateable to between the mid-12th to 13th century, three fragments of North Devon Gravel-Tempered Ware which can be dated to the 17th and 18th centuries along with 13 fragments of earthenware and six fragments of porcelain/china that belong to a broad date range between the 18th and early 20th century. The presence of the later pottery clearly indicates the Ham Green Ware and North Devon Gravel-Tempered Wares are residual fragments. This deposit would appear to represent imported levelling material, possibly associated with a late post-medieval building on the site. The origin of the material is unclear, although it indicates medieval activity in its vicinity.
- 6.1.4 Deposit 110, which appeared to represent redeposited material infilling structure 103, contained a fragment of blue-glazed earthenware of the 18th to mid-20th century.
- 6.1.5 Within **Test Pit 2** the lower deposit 130 contained a fragment of Ham Green Ware (mid-12th – 13th century) along with three jug fragments of Minety-type ware, dateable to a broader period between the early or mid-12th century to 15th century. The absence of post-medieval pottery is striking, and would suggest this is a medieval deposit, and by inference so is the rock-cut gully within which it largely sits (cut 131). As a combined assemblage the pottery would suggest a potential mid-12th to 13th century date.
- 6.1.6 The overlying deposit 129 also contained four fragments of glazed red earthenware of a 13th to 15th century date. These would appear to be residual fragments however as numerous fragments of late post-medieval red earthenwares were also contained within this deposit. A fragment of Minety-type ware was also recovered from the topsoil (deposit 133).

- 6.1.7 Within **Test Pit 3** a lower stony soil layer (deposit 126) contained one fragment of glazed red earthenware dated to the 13th to 15th century. Other fragments of late post-medieval earthenware within the same deposit indicate the medieval pottery is residual. The topsoil (deposit 125) contained several fragments of earthenware and porcelain/china dated to between the 18th and mid-20th century, as well an earlier post-medieval fragment of red earthenware, dated to between the 16th and 17th century.
- 6.1.8 Within **Test Pit 4** a thick soil layer (deposit 114) towards the base of the test pit contained three fragments of potential medieval (13th to 15th century) glazed red earthenware. These were residual fragments as several fragments of late post-medieval (18th – early 20th century) glazed earthenwares and porcelain/china were contained within the same deposit. Overlying this was a layer of building rubble (deposit 113) that contained two fragments of Dyfed Gravel-tempered wares, used throughout the medieval period (late 12th – 15th century), along with one fragment of North Devon Gravel-tempered ware at a 17th or 18th century date. This may suggest this deposit originated from the demolition of a nearby structure as the finds are generally earlier than the deposit that is stratigraphically below it.
- 6.1.9 A thick soil layer (deposit 112) overlying the demolition rubble contained some unusual medieval pottery, consisting of a fragment of Saintonge Monochrome Ware (mid-13th – 15th century) and two fragments of Late Malvenian glazed wares (15th – 16th century), types of pottery not seen elsewhere on the site. Also contained within this deposit were twelve fragments of more typical late post-medieval earthenwares (18th – early 20th century). The topsoil (deposit 111) also contained a fragment of medieval pottery of Minety-type ware (early/mid 12th – 15th century), along with three fragments of North Devon Gravel-Tempered Ware (17th to 18th century) and numerous fragments of late post-medieval (18th – mid 20th century) porcelain/china and earthenware.
- 6.1.10 **Test Pit 5**, excavated into the limekiln crucible, revealed two main dumped deposits within the crucible itself. Both deposits contained a large quantity of pottery spread evenly throughout both deposits. Unfortunately it was not possible to distinguish the change between deposits during excavation, and as a result the finds were largely ascribed to the upper layer (deposit 120). A relatively small number of medieval fragments were recovered, including one fragment of Dyfed Gravel-tempered Ware (late 12th – 15th century) and four fragments of more generic glazed red earthenware (13th – 15th century), but later post-medieval pottery included 85 fragments of glazed red earthenware (17th – 18th century), 11 fragments of later glazed red earthenwares (18th – early 20th century), 13 other types of similarly dated earthenwares and 89 fragments of 18th to early 20th century porcelain/china.
- 6.1.11 **Test Pit 6** recovered only two fragments of pottery, one piece of china and one piece of red earthenware, both broadly dateable from the 18th to early 20th century. Both fragments came from a possible compacted surface (deposit 123).

6.1.12 A large quantity of pottery was recovered from the **spoil heap** (deposit 150) that was excavated under archaeological watching brief conditions. This deposit appeared to originate from modern dumping, possibly largely originating from the plot to the west. Unusually no medieval pottery was recovered. A typical assemblage of glazed earthenwares, porcelain and china dateable from the 18th century to late 20th century was recovered, totalling 134 fragments.

6.2 Glass

6.2.1 A total of 134 pieces of glassware were recovered from the site, including a large number of complete bottles.

6.2.2 **Test Pit 1** contained four fragments of typical 18th to early-20th century glass within the topsoil (deposit 100) and a thick levelling deposit (102).

6.2.3 **Test Pit 4** contained two fragments of similar late post-medieval glass within the topsoil deposit (111).

6.2.4 **Test Pit 5** contained twenty fragments of 18th to early 20th century glass from the upper infilling deposit within the limekiln crucible (deposit 120).

6.2.5 The largest quantity of glassware came from the **spoil heap** against the western boundary wall. This contained 49 fragments of 19th to 20th century bottle glass, along with 5 fragments of similarly dated window glass. 24 complete bottles were also recovered, dateable to between the 19th and later 20th century.

6.3 Animal Bone

6.3.1 In total 109 fragments of animal bone was recovered from the site, all of which came from later post-medieval and modern contexts and largely represented discarded food waste. With the exception of Test Pit 5, bone recovered from test pit deposits were small in number and add little to the interpretation of the deposits from which they were recovered.

6.3.2 Within **Test Pit 1** eight fragments were recovered from levelling deposit 102 with a further small fragment also recovered from possible surface deposit 106 and a fragment recovered from deposit 110 which may sit within structure 103.

6.3.3 Within **Test Pit 3** four fragments were recovered from deposit 126.

6.3.4 Within **Test Pit 4** one fragment was recovered from the topsoil, one fragment from underlying deposit 112 and three fragments from the lower deposit 114.

6.3.5 Within **Test Pit 5** 79 fragments were recovered. These have been ascribed to deposit 120, but are likely to have been spread throughout deposits 120 and 121. These fragments vary in size but come from a range of animals, many showing butchery marks, and representing food waste. The quantity of animal bone within these

deposits may be an indication that the open limekiln crucible was used as a general rubbish dump.

- 6.3.6 Eleven fragments of animal bone were recovered from the **spoil heap** deposit (deposit 150).

6.4 Metallic objects

- 6.4.1 From within **Test Pit 1** two iron objects, which includes a horse shoe, were recovered from the general levelling deposit 102. Both objects would appear to be late post-medieval in date. A further 19th or 20th century iron object was recovered from deposit 110, which may lie within structure 103. None of these finds give any real clue as to the function of the post-medieval building situated here.
- 6.4.2 A large number (17 pieces) of largely unidentifiable metallic objects were recovered from infill deposit 120, within the limekiln crucible (**Test Pit 5**). No objects of note were recovered, and they appear to form part of the general deposit of waste material that would appear to characterise the infill material of the limekiln crucible.
- 6.4.3 A wide variety of metallic objects were recovered from the **spoil tip** deposit (150). This included a number of unidentifiable objects, along with 20th century material such as a spade head, pick head, fragments of bucket and iron railing. The objects would appear to represent discarded objects, largely of 20th century date. Three somewhat more unusual items were recovered, and include a decorate finial possibly from fence railings or a lightning rod, a rabbit gin trap of the early to mid-20th century and the base of a steamship chair, similar to examples known from the 1920s.

6.5 Others

- 6.5.1 Several fragments of late post-medieval or early modern (18th to early 20th century) clay pipe stems were recovered from several deposits, but not in any significant quantity with the exception of deposit 120, the infilling deposit of the limekiln crucible. This deposit contained 93 fragments, including some green-glazed stems, ranging in dates from the 17th through to the 19th century. The earlier examples are assumed to be residual as they pre-date the use of the limekiln itself. The quantity of pipe stem fragments adds to the picture of general waste material.
- 6.5.2 A large number of oyster shell fragments were recovered from a number of deposits throughout the site, again with the largest quantity from deposit 120 within the limekiln crucible. All fragments came from later post-medieval deposits and are common finds of this period, used as a cheap and readily-available food source.

7 Discussion and Conclusions

- 7.1 An archaeological evaluation, comprising the hand-excavation of six test-pits, was undertaken within the rear garden plot of the Tabernacle Church, Pembroke. The work was undertaken both as part of a planning condition and also to help inform the development of the site as 'The Journey Through Time', a project put forward by Pembroke 21C community association to use the site to tell the story of Pembroke's history through planting and interpretation panels.
- 7.2 The archaeological potential of the site has been laid out in a previous desk-based assessment. This highlighted a general potential for Palaeolithic and Mesolithic remains associated with a cave site located on the site, along with a general potential for inferred Iron Age and early medieval archaeology on the limestone ridge upon which Pembroke is located. However, no evidence of prehistoric or early medieval activity was identified during the course of the evaluation. Due to the potential presence of roosting bats, cave deposits were not examined, and the depth of modern overburden was too great to examine deposits around the cave entrance
- 7.3 The periods of greatest potential identified by the desk-based assessment were the medieval and post-medieval. The site occupies medieval burgage plots and lies within the bounds of the medieval defensive town wall, which was erected in the late 13th/early 14th century. Above ground remains of the wall no longer exist, but it is thought to follow the line of the southern boundary wall of the site, although alternative alignments are possible. Activity within the site is unrecorded until the later post-medieval period when quarrying activity is noted and a limekiln was built into the southern boundary wall, possibly in the late 18th century. Two buildings are recorded on a ridge along the northern edge of the site in the 1860s, shortly before the site was purchased by the Tabernacle Church; the church was erected in 1867/8. Garden terracing is noted along the eastern side of the site, but otherwise there is no recorded mention of activity specifically within the bounds of the site.
- 7.4 One probable medieval feature was revealed. Within T2 towards the northeast corner of the site a relatively substantial rock-cut gully (Gully 131) was identified. The lack of any associated structural material and the gradual southward slope suggests this is a drainage feature. It was infilled by a deposit (130) that appears to represent abandonment, therefore post-dating the use of the gully. This deposit contained medieval pottery possibly concentrated on the mid-12th to 13th century. The original creation and use of the gully, therefore, would be earlier, although as there was no underlying deposits it is unlikely to predate it by a significant period of time. The town of Pembroke was believed to be expanding into this area during the 13th century. This gully may, therefore, represent methods of drainage related to the earliest stages of settlement, which is likely to have been concentrated along Main Street.
- 7.5 No evidence of the medieval town wall was revealed. T4 and T5 indicate that deposits located to the rear of the southern boundary wall, which is believed to represent the line of the earlier town wall, were built up to significant depths in the later post-medieval period; the boundary wall itself comprised only late post-medieval fabric. No

wall remains, construction or demolition material, that may be medieval in date were revealed in any of the other test pits to suggest any alternative route for the line of the town wall. It is possible that this medieval wall was largely removed during post-medieval quarrying activity in this area (see below).

- 7.6 General activity during the medieval period was indicated, however, by the spread of medieval pottery throughout the site. For a large part the medieval pottery comes from quite a broad date range and includes jugs and plates typical of an urban setting in this region. It is consistent with the general pattern of urban expansion that took place in this area from the 13th century onwards. Relatively early activity is, however, indicated by the presence of Ham Green Ware of the mid-12th to 13th century, recovered from within the gully mentioned above, and also as residual fragments from T1 along the northern edge of the site.
- 7.7 The majority of finds and activity on the site appear to date to the 18th, 19th and 20th centuries. There is also a spread of pottery dateable to the 17th and 18th centuries throughout the site, again typical of an urban setting, but nothing, for example, to suggest increased activity associated with the defence of the town during the civil war period. The presence of a layer of demolition material containing pottery of 17th/18th century date within T4 (deposit 113) suggests the possibility that some structures within the site that may date to this period. Although the material itself appears to have been deposited in the later 18th or, more likely, the 19th century, presumably after the demolition of an earlier structure.
- 7.8 Along the eastern edge of the site the underlying natural bedrock was recorded at 11.93mOD in T2, and at 8.64mOD in T3, indicating that the slope in current ground levels along the garden terraces at the eastern half of the site roughly mirrors the underlying natural bedrock. No bedrock was reached in T4, however, which reached a level of 6.6mOD, suggesting the bedrock drops away more steeply towards the southern edge of the site. A considerable depth of infill and build-up of deposit along the southern edge of the site to the rear of the boundary wall is indicated. Quarrying has already been noted in the western half of the site, but the marked change from sloping bedrock in the eastern half, to vertical rock faces in the western half suggests significant deposits in the western half of the site (and beyond) have been removed through quarrying. It is presumed that this quarrying is post-medieval in date and, given that the vertical rock face extends westward beyond the limits of this burgage plot, it presumably also predates the establishment of the tan yard in the neighbouring burgage plot, which is known to have been in existence by the late-18th century. It seems likely, however, that some degree of quarrying continued in the late-18th/early-19th century in association with the limekiln established along the southern boundary.
- 7.9 The limekiln was investigated in T5. This revealed the rear wall of the crucible. Measurements to the visible southern wall of the kiln would make the internal diameter at the top of the crucible at most 4.8m wide. However, other known limekiln examples have an internal ledge that run around the structure, between the crucible and the external wall of the kiln. Therefore the internal diameter is likely to be smaller.

The interior of the wall funnels inwards, although it appears to have lost its facing stones. Whether these have been removed or tumbled to the base of the crucible could not be safely established. To the rear (north) of the kiln a large deposit of limestone pieces had built up against the wall. These stones were of a size suitable for burning within the kiln, and therefore may represent quarried stone ready for burning. Alternatively it may represent a quarried deposit used as part buttress and part access ramp to get to the kiln crucible. Only the upper levels of the infilling deposits of the crucible were investigated. However, it would appear that the crucible was being used as a dump, certainly by the mid to late 19th century, and contained a significant amount of material and waste pottery, glass, bone and metallic items. As these were clearly post-use depositions, no material was recovered that may indicate a working date for the kiln, which remains dated on stylistic grounds to the later 18th century.

- 7.10 Along the northern edge of the site, two buildings were identified on maps of the 1860s. A small building within the northeast corner appears to correspond to the stone-built outbuilding that still exists. It is clear that this building was subsequently modified in the later 19th and 20th centuries. Access from the building into the adjacent burgage plot to the east is likely to have been created sometime after 1878, when the adjacent plot was acquired to build the manse associated with the Tabernacle Church. An internal 20th century brick wall and sewer pipe indicate the building was also modified to function as an external toilet for the church. The building to the west only appears briefly on the Ordnance Survey maps of the 1860s. The bedrock revealed within T1 indicates that this area has been terraced into the bedrock, and the eastern limit of the building is indicated by a rock-cut ledge topped with mortared masonry. T1 revealed at least two-phases of activity. Initially a surface (deposit 106) appears to have been laid over the bedrock (c.0.6m below current ground levels), while heat-affected deposits (104) are also noted at this level that may have originated from a hearth or oven. There were, however, few finds to give a definitive clue to the nature of the activity undertaken at this stage, and the finds are dateable to a rather broad, 18th to 19th century, date. Overlying these layers was a make-up deposit providing a break between the phases of activity, which was subsequently cut by structural remains. The function of wall remnants 103 in the corner of the test pit remains uncertain, but wall 101 appears to align closely to the external wall of the structure when overlaid on the Ordnance Survey mapping (see Figure 10). However, wall 101 is not substantial, which indicates it supported a light-weight structure. The spread of heat-affected material from the initial phase, and the lightweight nature of the 2nd phase structure suggests a structure semi-industrial in nature rather than domestic. This interpretation is also borne out by the relatively small number of finds of a domestic nature recovered from recorded deposits. The boundary wall to the west, with its L-shaped return, has been suggested as the possible surviving elements of the western gable wall to this structure. However, the nature of wall 101 and mapping evidence indicates that the gable wall stood to the east of this standing wall.

8 Development impact

- 8.1 Current development proposals consist largely of minor landscaping and planting, along with the establishment of some interpretation panels and fencing. The main intrusive works proposed include plans to establish a stair access to the Tabernacle Church in the northwest corner of the site, and initial proposals to empty and restore the limekiln crucible.
- 8.2 The depths of garden topsoils and underlying soil deposits revealed in T2 – T4 suggest that planting regimes and the establishment of footpaths will have little or no impact on potential archaeological remains. Indeed, the only specific archaeological feature identified in this area was a rock-cut gully at a depth of 0.5m below current ground levels. Surface remains include low terrace walling defining the garden terraces, but these will be retained within the development.
- 8.3 Along the western side of the site, T6 indicated a possible rough surface of late post-medieval date at depths of 0.3m below initial ground levels. However soil from the spoil heap that stood in this area has now been spread throughout the area, providing an even greater depth of overlying material to protect any potential below-ground remains.
- 8.4 Late post-medieval wall remains were identified relatively close to the surface along the northern ledge within the site, which appears to correspond to the building outline defined on the 1866 Ordnance Survey map. Due to the unstable nature of an overhanging brick-built structure in the northwest corner of the site, along with the line of a sewer that has been identified running east – west immediately to the south, it was not possible to expand the test pit to investigate the wall remains further. Initial proposals to remove roots within the topsoil that could potential disturb these shallow wall remains have also been modified, and the likelihood is that ground levels will instead be built up in this area, with the wall remains left undisturbed. There is still a potential, however, that foundation work associated with the access arrangements to the Tabernacle Church will disturb remains associated with this building.
- 8.5 By defining the location of the limekiln crucible wall, it should now be possible to position any fencing required in this area to avoid damaging underlying structural remains. It was only possible to safely investigate the upper fills of the crucible. However, the evidence indicates that any clearance works within the crucible are likely to require the removal of extensive amounts of material, including ceramics, glassware, animal bone and metalwork, although the deposits themselves are clearly mid-19th century or later in date. The internal wall of the crucible appears to have lost its facing stones and is, therefore, likely to require extensive renovation works to prevent its degradation should it become exposed to the elements.

9 Bibliography

Published

- Anon 2013 'Battle is on to save town walls' in *Pembrokeshire Life*, Sept. 2013, pp 7-9
- Beresford, M 1988 *New Towns of the Middle Ages* London
- Boon, GC 1986 *Welsh Hoards 1979-81* Cardiff, National Museum of Wales
- Carradice, P 1992 *Pembroke for King & Parliament* Pembroke Town Council
- Eynon, M ? *Pembroke: A brief History*
- Harries, J 2011 'A proud history but an uncertain future' in *Pembrokeshire Life*, May 2011, pp 4-6.
- Holden 1811 *Holden's Annual London and County Directory of United Kingdoms and Wales, Vol. III*
- Hunt & Co 1850 *Directory & Topography...* London
- Pigot & Co. 1835 *National Commercial Directory* London
- Rose, R 2000 *Pembroke People* Otterquill Books
- Slater 1880 *Slater's Royal National Commercial Directory of North and South Wales, Monmouthshire, Shropshire and the Cities of Bristol and Chester*
- Smith, TP 1985 'Why did medieval towns have walls?' in *Current Archaeology* 8
- Soulsby, I 1983 *The Towns of Medieval Wales: A study of their History, Archaeology and Early Topography* Phillimore

Unpublished

- Crane, P 2000 *PRN 40601*, consisting of a context sheet, brief notes and sketch plan made during a site visit during the demolition and partial rebuild of town wall section.
- Crane, P 2012 *Pembroke Cycle Way, Bridgend Terrace, Pembroke: Archaeological Watching Brief* Dyfed Archaeological Trust Report No. 2012/36
- GGAT 1995a *Drill Hall, Pembroke; Trial Trenches* Glamorgan-Gwent Archaeological Trust Report No. 95/057
- GGAT 1995b *Archaeological Evaluation at South Quay, Pembroke. Final Report* Glamorgan-Gwent Archaeological Trust Report no. 95/018
- Howells, S n.d. *Report of a brief survey of geological features within the Tabernacle Garden, Pembroke*
- Ludlow, N 1993 *North and South Quay, Pembroke: An Initial Archaeological Assessment* Dyfed Archaeological Trust Report PRN 32484
- Ludlow, N 2001 *Pembroke Town Walls Project: Archaeological Interpretation and Condition Survey* Pembroke Design Ltd & Cambria Archaeology

- Pannett, A 2009 *Tudor House, Pembroke: Archaeological Excavation and Watching Brief*
Cambrian Archaeological Projects Report No. 552
- Poucher, P 2015 *Tabernacle Church & Town Wall, Pembroke: Archaeological Desk-Based Assessment* Archaeology Wales Report No.1346
- Ratty, S & Meek, J 2010 *South Quay, Pembroke: Desk-Based Assessment* Dyfed
Archaeological Trust Report No. 2010/01

Maps

- | | | |
|-----------------|------|---|
| Ordnance Survey | 1864 | <i>1:500 map, Pembroke</i> |
| Ordnance Survey | 1866 | <i>1st edition 1:2500 map, Pembrokeshire</i> |
| Ordnance Survey | 1869 | <i>6 inch to the mile map, Pembrokeshire</i> |
| Ordnance Survey | 1908 | <i>2nd edition 1:2500 map, Pembrokeshire</i> |
| Ordnance Survey | 1967 | <i>1:2500 plan, Pembrokeshire</i> |
| Ordnance Survey | 1975 | <i>1:2500 plan, Pembrokeshire</i> |
| Ordnance Survey | 1989 | <i>1:1250 plan, Pembrokeshire</i> |
| Speed, J | 1610 | <i>Pembrokeshire</i> |



Figure 1: Location map showing site & study area. Based on Ordnance Survey 1;50,000 (@A4)

The Ordnance Survey has granted Archaeology Wales Ltd a Copyright Licence (No. 100055111) to reproduce map information; Copyright remains otherwise with the Ordnance Survey.

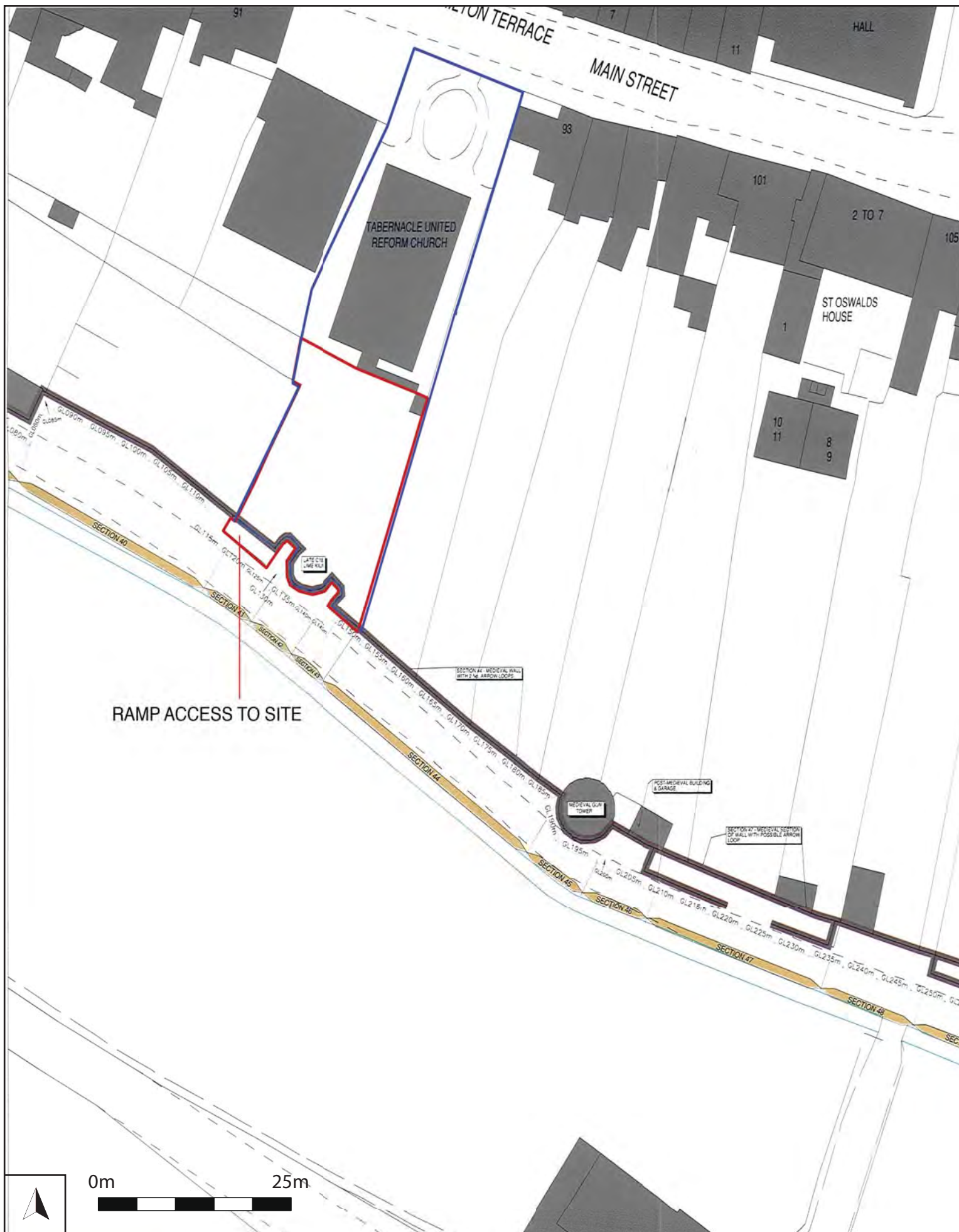

Figure 2: Site location plan. Tabernacle Church property boundary in blue, site location in red.

Plan provided by Ancanthus Holden, via Pembroke 21C.



Figure 3: Test Pit location plan overlaid on a topographical survey of the site. Excavated test pits marked in red, labelled by test pit number. Identified archaeological features marked in blue.

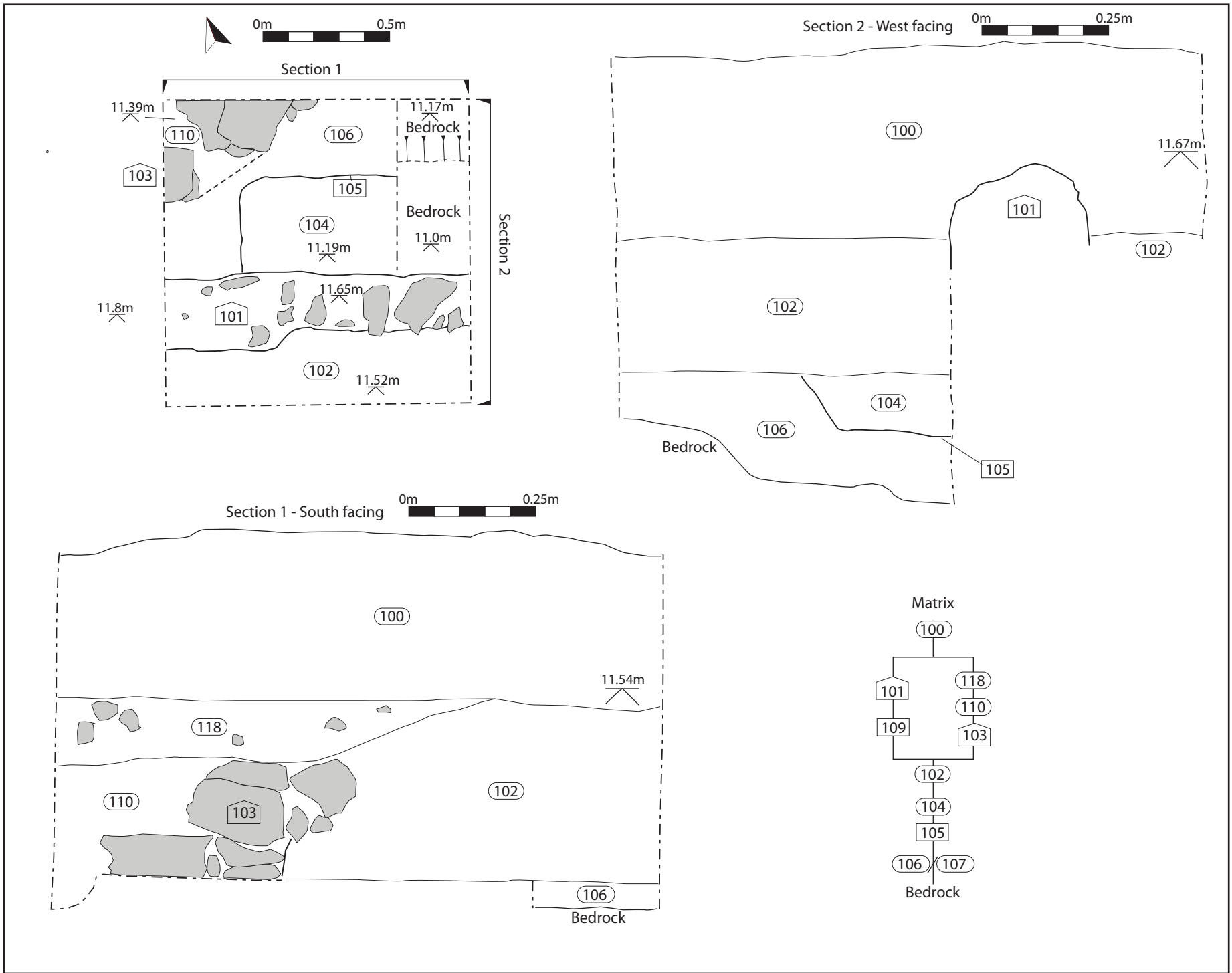
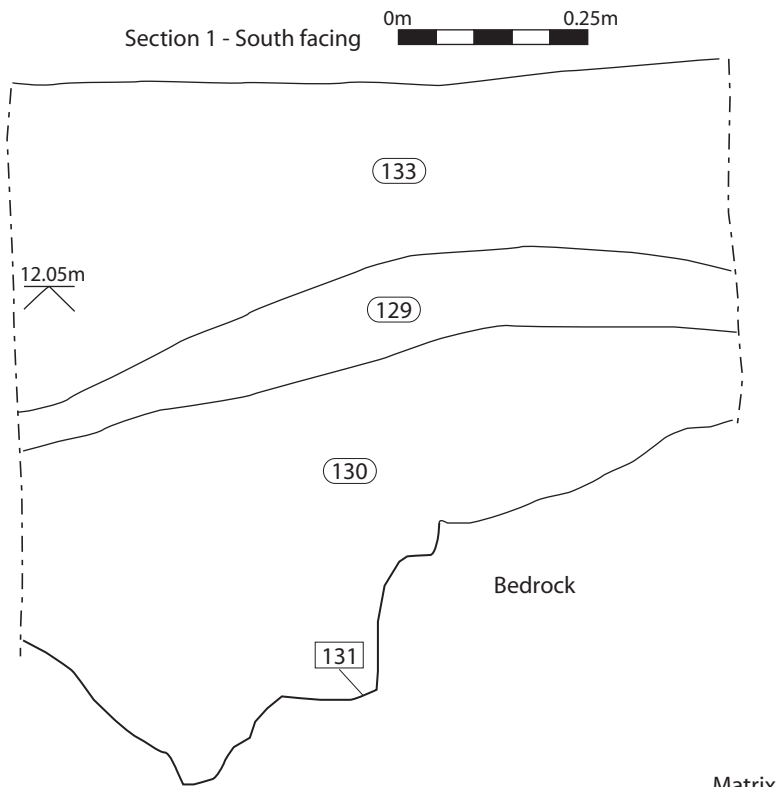
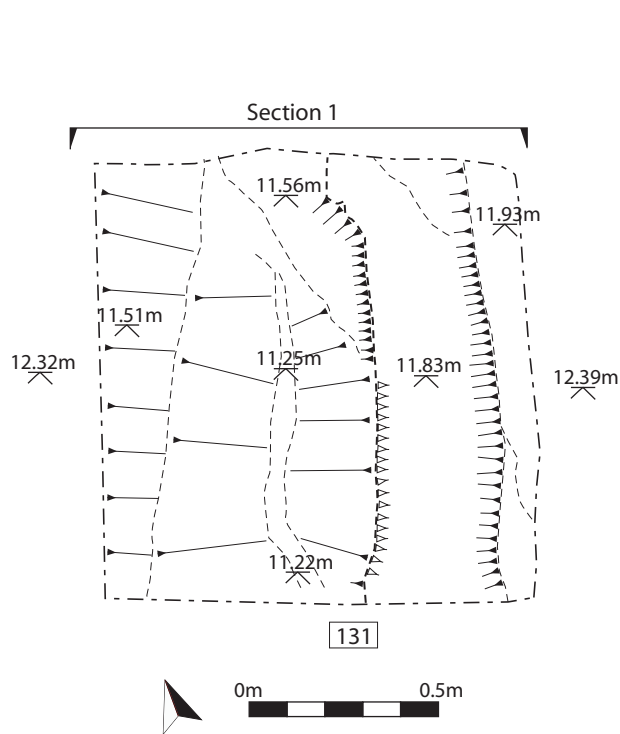

Figure 4: Test Pit 1 plan (top left) and sections.

Plan drawn at 1:20 @ A4
 Sections drawn at 1:10 @ A4

All levels given at height in metres above Ordnance Datum.



Matrix

133

129

130

131

Bedrock

Figure 5: Test Pit 2 plan (left) and section (right).

Plan drawn at 1:20 @ A4
Sections drawn at 1:10 @ A4

All levels given at height in metres above Ordnance Datum.

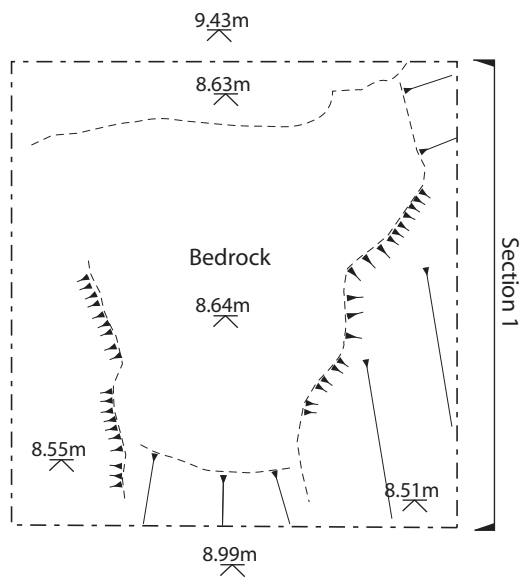

Matrix
 (125)
 (126)
 (128)
 Bedrock

Figure 6: Test Pit 3 plan (left) and section (right).

Plan drawn at 1:20 @ A4
 Sections drawn at 1:10 @ A4

All levels given at height in metres above Ordnance Datum.

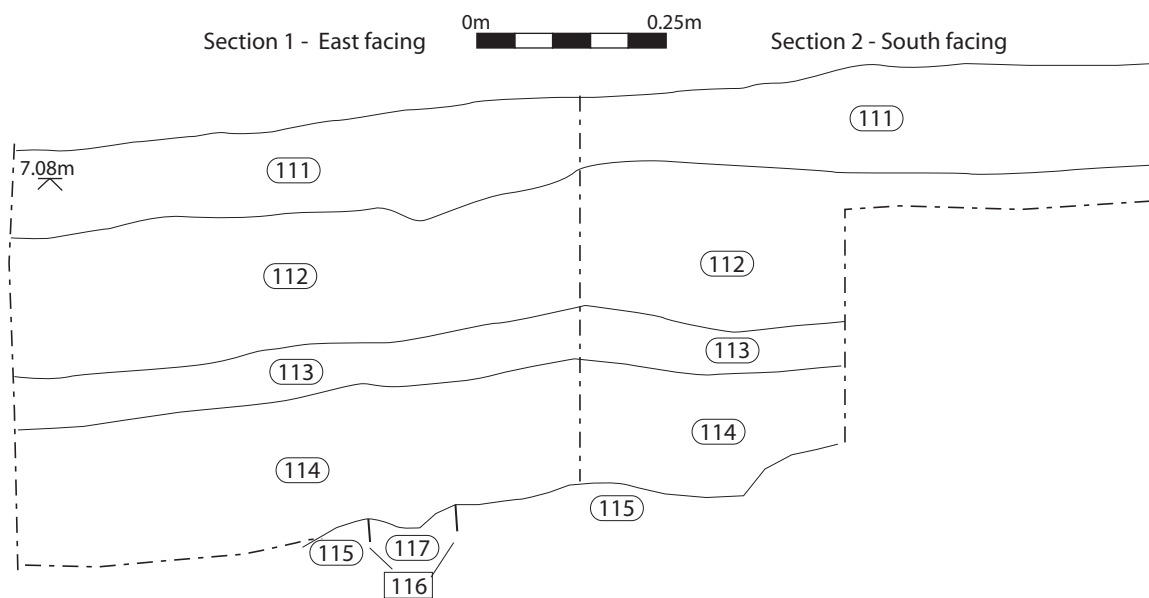
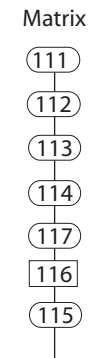
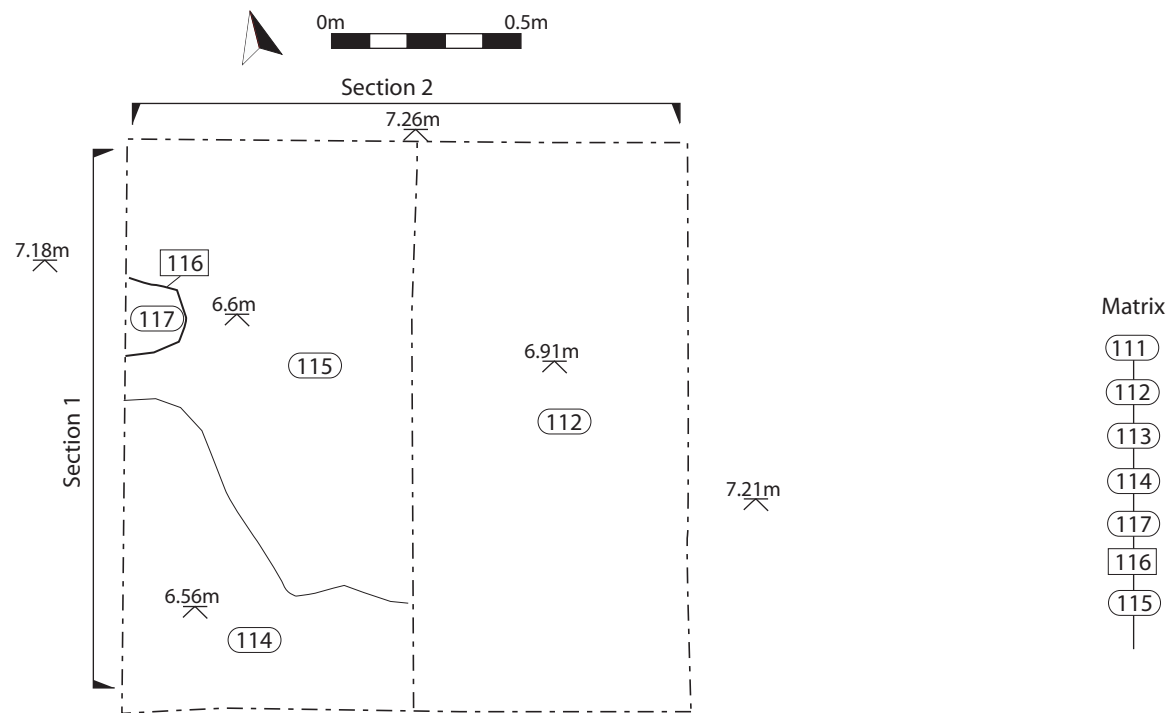

Figure 7: Test Pit 4 plan (top) and section (bottom).

Plan drawn at 1:20 @ A4
Sections drawn at 1:10 @ A4

All levels given at height in metres above Ordnance Datum.



Figure 8: Test Pit 5 plan (top) and section (bottom).

Plan drawn at 1:20 @ A4
 Sections drawn at 1:10 @ A4

All levels given at height in metres above Ordnance Datum.

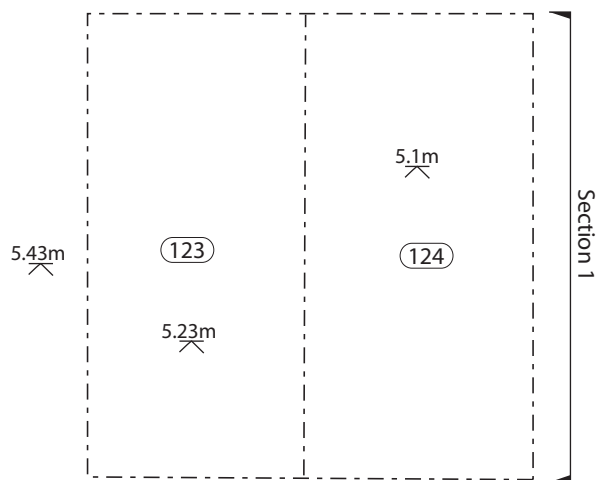

Section 1 - West facing

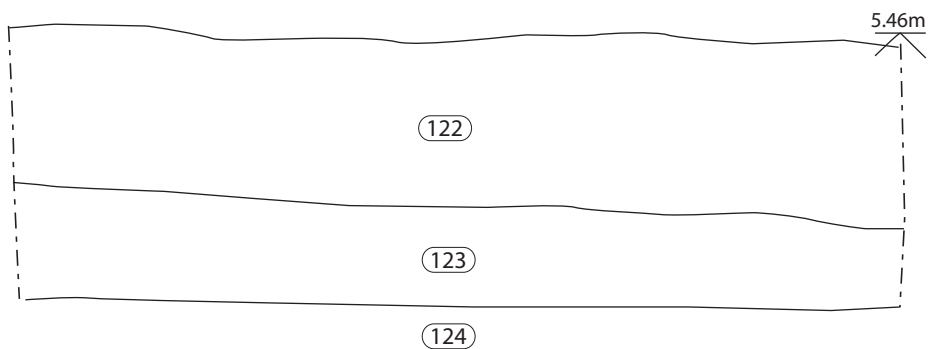

Matrix

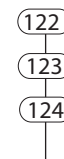

Figure 9: Test Pit 6 plan (left) and section (right).

Plan drawn at 1:20 @ A4
Sections drawn at 1:10 @ A4

All levels given at height in metres above Ordnance Datum.



Figure 10: Test Pit location plan (in red) with identified archaeological features (in blue) overlaid on the 1st edition Ordnance Survey map of 1866. Site outline in green.



Photo 1: General view of the rear garden plot, facing NNE, with the Tabernacle Church in the background.



Photo 2: North facing shot of the site showing level difference between the lower eastern half, raised northern ledge, and level of the Tabernacle church to the rear.



Photo 3: NE facing shot of southern boundary wall showing limekiln and level of excavations above the kiln.



Photo 4: West facing shot of Test Pit 1, showing wall 101 along the left. 1m scales.



Photo 5: NW facing shot of Test Pit 1, taken in strong sunlight. 1m scales.



Photo 6: North facing shot of Test Pit 1. 1m scale.



Photo 7: North facing shot of the section of Test Pit 1. 1m scales.



Photo 8: East facing shot of the section of Test Pit 1. 1m scale.



Photo 9: North facing shot of Test Pit 2. 1m scales.



Photo 10: North facing plan shot of Test Pit 2. 1m scale.



Photo 11: East facing plan shot of Test Pit 2. 1m scale.



Photo 12: South facing shot of the section of Test Pit 2. 1m scale.



Photo 13: North facing shot of the section of Test Pit 2. 1m scale.



Photo 14: West facing plan shot of Test Pit 3. 1m scale.



Photo 15: East facing plan shot of Test Pit 3, showing deposit 127 before excavation. 1m scales.



Photo 16: North facing shot of the section of Test Pit 3. 1m scales.



Photo 17: East facing shot of the section of Test Pit 3. 1m scale.



Photo 18: North facing shot of the section of Test Pit 4. 1m scale.



Photo 19: West facing shot of the section of Test Pit 4. 1m scale.



Photo 20: North facing plan shot of Test Pit 4. 1m scale.



Photo 21: East facing shot of the section of Test Pit 5. 1m scales.



Photo 22: North facing shot of Test Pit 5, showing the inner face of wall 119. 1m scales.



Photo 23: East facing shot showing the width of top of wall 119 in Test Pit 5. 0.3m scale.



Photo 24: East facing plan shot of Test Pit 6. 1m scales.



Photo 25: East facing shot of the section of Test Pit 6. 1m scale.



Photo 26: North facing shot of the northern-most garden terrace wall on the eastern part of the site, revealed during tree clearance work, showing the footpath along the face of the boundary wall. 1m scale.



Photo 27: NE facing shot of the return on the garden terrace wall demarcating the footpath.
1m scale.



Photo 28: Steps revealed in neighbouring plot taking footpath between garden terraced
against the boundary wall.



Photo 29: General shot facing SW, showing spoil heap in lower right-hand corner prior to removal.



Photo 30: General shot facing north, showing loose nature of spoil tip prior to its removal.



Photo 31: As above, showing the area after the spoil tip was reduced and spread. 2m scales.



Photo 32: West facing shot showing western boundary wall after spoil tip was removed and spread. 2m & 1m scale.



Photo 33: A series of steps between the two main levels on the site, built against the western boundary wall and partly uncovered. 1m scale.



Photo 34: As above, looking NW. 1m scale.



Photo 35: Decorative finial recovered from the spoil heap.



Photo 36: Rabbit gin trap recovered from the spoil heap.



Photo 37: Base of a steamship chair, engraved with the makers name (Carron & Co).



Photo 38: Detail of the chair legs.

Archaeology
Wales

**APPENDIX I:
Finds Register**

Archaeology Wales Ltd.

Finds catalogue Tabernacle & Town Wall, Pembroke

Site code: TTWP/15/EV

Number	Context	Remarks	Date	Amount
Pottery				
Topsoil	100	Post med.	18/19th C	1
Test pit 1	100			
Test pit 1	102	Porcelain/china	18-20th C	6
		Other earthenware	18-20th C	13
		Glazed red e.w.	See Pot Rep	3
		Medieval	13-15th C	4
		Glazed red earthenware	See Pot Rep	2
Test pit 1	106	Porcelain/china	18-20th C	1
		Other earthenware	18-20th C	1
Test pit 1	107	Glazed red earthenware.	See Pot Rep	1
Test pit 1	110	Glazed red earthenware.	18-20th C	1
Test pit 4	111	Porcelain/china	18-20th C	7
		Other earthenware	18-20th C	5
		Glazed red earthenware.	13-15th C	1
		Glazed red earthenware	See Pot Rep	3
		Glazed red earthenware	See Pot Rep	1
Test pit 4	112	Other earthenware	18-20th C	12
		Glazed red earthenware	See Pot Rep	1
		(Glazed) red earthenware	See Pot Rep	2
Test Pit 4	113	Red earthenware	See Pot Rep	2
	113	Glazed red earthenware	See Pot Rep	1
Test pit 4	114	Porcelain/china	18-20th C	3
		(Glazed) red earthenware	18-19th C	5
		Glazed red earthenware	13-15th C	1
		Glazed red earthenware	Possibly med.	2
Test pit 5	120	Porcelain/china	18-20th C	89
		Glazed red earthenware	17-18th C	85
		Glazed other earthenware	18-19th C	13
		Glazed red earthenware (incl. Buckley ware)	18-20th C	11
		Glazed red earthenware	13-15th C	4
		Glazed red earthenware	See Pot Rep	8
		Glazed red earthenware	See Pot Rep	1
Test pit 6	123	Porcelain/china	18-20th C	1
		Red earthenware	18-20th C	1
Test pit 3	125	Porcelain/china	18-20th C	3
		Other earthenware	18-20th C	2
		Glazed red earthenware	16-17th C	1
Test pit 3	126	Red earthenware	18-20th C	3
		Glazed red earthenware	See Pot Rep	1
Test pit 2	129	Red earthenware	18-20th C	11
		Glazed red earthenware	13-15th C	4
Test pit 2	130	Glazed red earthenware	See Pot Rep	3

		Glazed red earthenware	See Pot Rep	1
Test Pit 2	133	Glazed red earthenware	See Pot Rep	1
Spoil Heap	150	Terracotta plant pots	19-20th C	2
		Porcelain/china	18-20th C	97
		Glazed red earthenware	18-20th C	16
		Glazed other earthenware	18-20th C	21
CBM				
Test pit 1	102		18-20th C	2
Test pit 4	115		18-20th C	1
Test pit 5	120		18-20th C	5
Glass				
Test pit 1	100		18-20th C	1
Test pit 1	102		18-20th C	3
Test pit 4	111		18-20th C	2
Test pit 5	120		18-20th C	20
Spoil Heap	150	Bottle neck	19-20th C	30
		Bottle bottom	19-20th C	11
		Loose sherds	19-20th C	8
		Window	19-20th C	5
		Complete bottles	19-20th C	24
Animal bone				
Test pit 1	102		18-20th? C	8
Test pit 1	106		18-20th? C	1
Test pit 1	110		18-20th? C	1
Test pit 4	111		18-20th? C	1
Test pit 4	112		18-20th? C	1
Test pit 4	114		18-20th? C	3
Test pit 5	120		18-20th? C	79
Test pit 4	126		18-20th? C	4
Spoil Heap	150		18-20th? C	11
Metal				
Test pit 1	102	Post med. Incl 1 horse shoe	18-20th? C	2
Test pit 1	110	Iron object.	19-20th C	1
Test pit 5	120	Metal objects	18-20th? C	17
Spoil Heap	150	Metal objects	19-20th C	9
Tabacco clay pipe				
Test pit 1	102	Post med.	18-20th C	2
Test pit 1	106	Post med.	18-20th C	3
Test pit 4	111	Post med.	18-20th C	2
Test pit 5	120	Post med. Incl. 9 green glazed stems	17-19th C	93
Shell				
Test pit 1	102	Shells	18-20th? C	7
Test pit 1	106	Shells (oyster)	18-20th ? C	2
Test pit 4	111	Shells (oyster)	18-20th? C	2
Test pit 4	112	Shell (oyster)	18-20th? C	1
Test pit 4	114	Shells (oyster)	18-20th? C	2

Test pit 5	120	Shells (oyster 69, cockles 58)	18-20th ? C	127
Test pit 3	126	Shells (oyster)	18-20th? C	1
Test pit 2	129	Shells (oyster)	18-20th? C	4

Miscellaneous

Test pit 2	129	Slate, incl 1 roof tile	18-20th C	3
------------	-----	-------------------------	-----------	---

Total finds:

Pottery	433
CBM	8
Glass	104
Bone	109
Metal	29
Tabacco clay pipe	100
Shells	146
Miscellaneous	3

Total: 932

Pottery from the Tabernacle Chapel and Town Wall, Pembroke (Site TTWP/15/EV)

Paul Blinkhorn

The pottery assemblage comprised 31 sherds with a total weight of 445g. It was all medieval or later. The following fabric types were noted:

DTG: Dyfed Gravel-Tempered Wares, late 12th - 15th century (O'Mahoney 1995, 9). 3 sherds, 28g.

HGW: Ham Green Ware, mid 12th – 13th century (ibid., 16). 3 sherds, 14g.

LMO: Late Malvenian Glazed Wares, 15th – 16th century (Vince 1977). 2 sherds, 2g.

MIN: Minety-type Ware, early/mid 12th – 15th century (O'Mahoney 1995, 15). 6 sherds, 62g.

NDG: North Devon Gravel-tempered Ware, 17th – 18th century (ibid. 1995, 29). 16 sherds, 337g.

SMW: Saintonge Monochrome Ware, mid 13th – 15th century (ibid. 33). 1 sherd, 2g.

The pottery occurrence by number and weight of sherds per context by fabric type is shown in Table 1. Each date should be regarded as a *terminus post quem*. The range of fabric types is typical of sites in the region, consisting mainly of English wares, and comparable with that from, for example, Carmarthen Greyfriars (ibid.). Apart from a single sherd of an unglazed DGT jar from context 113, all the sherds were from glazed vessels. These were all jugs except for the fragments of NDG which was from bowls, the main product of the tradition. The entire assemblage consisted of bodysherds, except for the rim and base of an NDG bowl from context (120), and a fragment of a thumb-frilled MIN jug base from context 130.

The assemblage is generally in fairly good condition, and, the residual material aside, appears reliably stratified.

Bibliography

O'Mahoney, C 1995, *Pottery, Ridge Tile and Ceramic Water Pipe, Excavations at Carmarthen Greyfriars 1983-1990*. Topic Report 2. Dyfed Archaeological Trust

Vince, AG, 1977 The Medieval and Post-Medieval Ceramic Industry of the Malvern Region: The Study of a Ware and its Distribution in DPS Peacock (ed.), *Pottery and Early Commerce. Characterization and Trade in Roman and Later Ceramics* Academic Press, London

Table 1: Pottery occurrence by number and weight (in g) of sherds per context by fabric type

Cntxt	DGT		MIN		HGW		SMW		LMO		NDG		Date
	No	Wt	No	Wt	No	Wt	No	Wt	No	Wt	No	Wt	
133			1	12									E/M12thC
102					2	10					3	25	17thC
107											1	27	17thC
111			1	2							3	6	17thC
112							1	2	2	2			15thC
113	2	15									1	23	17thC
120	1	13									8	256	17thC
126			1	13									E/M12thC
130			3	35	1	4							M12thC
Total	3	28	6	62	3	14	1	2	2	2	16	337	

Archaeology *Wales*

APPENDIX II: Context Register

Context Descriptions

Context Number	Context Type	Description	Dimensions (Length x width x thickness)
100	Layer	<ul style="list-style-type: none"> • Topsoil (T1) • Loose, dark grey-brown sandy-silt with abundant small sub-angular stone • Heavily root disturbed • 19th – mid 20th century glass and pot sherd 	>1.2m x >1.2m x 0.3m
101	Structure	<ul style="list-style-type: none"> • Wall (T1) • Linear, irregular sides, orientated east – west • Single course, large unworked limestone blocks set irregularly in hard, light pinkish-grey lime mortar with coal flecks throughout • Site within construction cut 109 	>1.2m x 0.2m x ?
102	Layer	<ul style="list-style-type: none"> • Make-up/Levelling deposit (T1) • Moderate, mid reddish-brown clayey-silt with abundant small angular stone and common flecks of coal and mortar • Quantity of 18th – early 20th century pottery, 17th – 18th century pottery and medieval pottery. 18th/19th century glass, animal bone, clay pipe stems and Fe object, including one horseshoe. 	>1.2m x >1.2m x 0.3m
103	Structure	<ul style="list-style-type: none"> • Masonry (T1) • Uncertain alignment, possibly curvilinear. • Uncoursed, large unworked limestone blocks bonded in a loose light brown-grey lime mortar 	>0.6m x 0.35m x 0.3m
104	Layer	<ul style="list-style-type: none"> • Fill of 105 (T1) • Loose, mid orange-brown clayey-sand, heat affected, with abundant coal flecks • No finds 	1m x 0.35m x 0.2m
105	Cut	<ul style="list-style-type: none"> • Shallow pit (T1) • Square/rectangular in plan, rounded corners • Shallow straight steep sides, sharp break of slope on to a flat base. • Contains a single fill (104) 	1m x 0.35m x 0.2m
106	Layer	<ul style="list-style-type: none"> • Trampled layer/surface (T1) • Moderate, mid grey-brown clayey-silt with abundant flecks of mortar. • 18th – early 20th century pottery and clay pipe stems, oyster shells, animal bone. 	>1.2m x 0.65m x 0.25m
107	Layer	<ul style="list-style-type: none"> • Same as 106 	
108	Cut	<ul style="list-style-type: none"> • Terraced bedrock (T1) • Levelled area roughly cut into limestone bedrock. Surface level and rough. 	>0.7m x >0.35m
109	Cut	<ul style="list-style-type: none"> • Construction cut for Wall 101 (T1) 	>1.2m x 0.2m x ?

		<ul style="list-style-type: none"> Assumed construction cut tight to wall foundations, no infilling material visible adjacent to wall 	
110	Layer	<ul style="list-style-type: none"> Redeposited material (T1) Loose, red-orange clayey-sand, heat-affected, with abundant coal flecks. One fragment of 19th – mid 20th century pottery, animal bone 	0.2m x 0.2m x 0.4m
111	Layer	<ul style="list-style-type: none"> Topsoil (T4) Loose, dark grey-brown sandy-silt with rare medium-large sub-angular stone. Heavily root disturbed. Medieval and 18th – mid 20th century pottery, 19th – 20th century glass, animal bone, clay pipe stem, oyster shell 	>1.2m x >1.2m x 0.22m
112	Layer	<ul style="list-style-type: none"> Levelling (T4) Moderate, mid-brown silty-clay with rare mortar and coal flecks Medieval and 18th to early 20th century pottery, animal bone, oyster shell 	>1.2m x >1.2m x 0.35m
113	Layer	<ul style="list-style-type: none"> Demolition layer (T4) Moderate, mid pinkish-brown clayey-silt with common mortar and coal flecks and common medium sub-angular stone. Medieval and 17th-18th century pottery 	>1.2m x >0.5m x 0.12m
114	Layer	<ul style="list-style-type: none"> Levelling (T4) Moderate, mid to dark brown silty-clay with common coal and mortar flecks and common medium sub-angular stone Medieval and 18th – early 20th century pottery, animal bone, oyster shell 	>1.2m x >0.5m x 0.4m
115	Layer	<ul style="list-style-type: none"> Possible surface (T4) Fairly compact, light reddish-brown clayey-silt with abundant small sub-rounded stone 19th – 20th century ceramic building material 	>1.2m x >0.5m
116	Cut	<ul style="list-style-type: none"> Possible posthole (T4) Sub-circular in plan Unexcavated Contains 117 	0.15m diameter
117	Fill	<ul style="list-style-type: none"> Fill of 116 (T4) Moderate, mid-brown silty-clay 	0.15m diameter
118	Layer	<ul style="list-style-type: none"> Disturbance (T1) Loose, mid orange-brown clayey-sand, heat affected, with abundant coal flecks and common medium sub-angular stone and mortar flecks No finds 	>0.65m x >0.8m x 0.12m
119	Structure	<ul style="list-style-type: none"> Limekiln wall (T5) Curvilinear, orientated east – west 	>1.2m x 0.4m+ x >1m

		<ul style="list-style-type: none"> Unworked limestone, well-sorted for size (0.15m x 0.1m x 0.1m), uncoursed, bonded within a pinkish-cream lime mortar. Steep, un-faced internal face 	
120	Layer	<ul style="list-style-type: none"> Dumped infill (T5) Fairly compact, mid-brown clayey-silt with common small angular stone and rare patches of lime mortar. Medieval, 17th-18th century and 18th – mid 20th century pottery, 19th-20th century CBM, 18th – 20th century glass, animal bone, unidentified metal objects, 17th – 19th century clay pipe stems, oyster shell 	1.7m x >1.2m x 0.45m
121	Layer	<ul style="list-style-type: none"> Dumped infill (T5) Loose, mid brown silty-clay with abundant medium-large sub-angular stone Finds mixed with layer 120 	1.5m x >1m x >0.8m
122	Layer	<ul style="list-style-type: none"> Topsoil (T6) Loose, dark grey-brown sandy-silt with rare medium-large sub-angular stone No finds 	>1.2m x >1.2m x 0.25m
123	Layer	<ul style="list-style-type: none"> Possible surface (T6) Fairly compact, dark grey-brown clayey-silt with abundant medium sub-angular stone 18th – mid 20th century pottery 	>1.2m x >1.2m x 0.15m
124	Layer	<ul style="list-style-type: none"> Levelling deposit (T6) Fairly compact, light orange-brown clay with abundant large sub-angular stone No finds 	>1.2m x >0.5m
125	Layer	<ul style="list-style-type: none"> Topsoil (T3) Loose, dark grey-brown sandy-silt with rare medium-large sub-angular stone 16th – 17th century and 18th – early 20th century pottery 	>1.2m x >1.2m x 0.2m
126	Layer	<ul style="list-style-type: none"> Demolition material? (T3) Moderate, mid grey-brown clayey-silt with common medium sub-angular stone and common coal flecks. Medieval and 18th – early 20th century pottery, oyster shells 	>1.2m x >1.2m x 0.2m
127	Layer	<ul style="list-style-type: none"> Demolition material? (T3) Moderate, light brown sandy-silt with abundant medium sub-angular stone and rare coal flecks Oyster shell, animal bone 	>1.2m x >1.2m x 0.4m
128	Bedrock	<ul style="list-style-type: none"> Limestone bedrock (T3) 	
129	Layer	<ul style="list-style-type: none"> Demolition material? (T2) Moderate, dark grey sandy-silty-clay with common small-medium sub-angular stone and abundant mortar flecks 	>1.2m x >1.2m x 0.12m

		<ul style="list-style-type: none"> • Medieval and 18th – early 20th century pottery, oyster shell, roof slate 	
130	Layer/Fill	<ul style="list-style-type: none"> • Fill of 131 (T2) • Moderate, dark brown silty-clay with common small-medium sub-angular stone • Medieval pottery 	>1.2m x >1.2m x 0.4m
131	Cut	<ul style="list-style-type: none"> • Rock-cut gully (T2) • Linear, orientated north –south, straight eastern edge, western edge not revealed. • Irregular steep to modern side, straight to concave. Roughly concave base • Infilled and overlaid by deposit 130 	>1.2m x 0.45m x 0.35m
132	Bedrock	<ul style="list-style-type: none"> • Limestone bedrock (T2) 	
133	Layer	<ul style="list-style-type: none"> • Topsoil (T2) • Loose, dark grey-brown sandy-silt with rare medium-large sub-angular stone • Medieval pottery 	>1.2m x >1.2m x 0.4m
134	Layer	<ul style="list-style-type: none"> • Topsoil (T5) • Loose, dark grey-brown sandy-silt with rare medium-large sub-angular stone • No finds 	>1.2m x >1.2m x 0.2m
135	Layer	<ul style="list-style-type: none"> • Makeup deposit (T5) • Loose, light brown sandy-silt with very abundant large sub-angular limestone blocks • No finds 	Unexcavated
150	Layer	<ul style="list-style-type: none"> • Spoil Heap deposit • Loose, dark grey-brown silty-clay with abundant medium-very large sub-angular stone and common mortar inclusions • 18th – late 20th century pottery, 19th – late 20th century glass and bottles, animal bones, metal items. 	11m x 7m x 1.5m

Archaeology
Wales

**APPENDIX III:
Written Scheme of Investigation**

**Written Scheme of Investigation
for an Archaeological Evaluation at
at The Tabernacle Chapel,
Pembroke**

**Prepared for:
Pembroke 21C Community Association**

Project No: 2319

Date: August 2015

NON TECHNICAL SUMMARY

This Written Scheme of Investigations details a proposal for the excavation of seven evaluation trenches in the rear burgage plot of Tabernacle Chapel, Pembroke, designed as a secondary investigation of potential buried archaeology within a proposed area of development. It has been prepared by Archaeology Wales Limited for Pembroke 21C Community Association.

1. Introduction

The proposed development plot occupies the rear burgage garden plot behind the Tabernacle Chapel in Pembroke, an area approximately 0.05ha, centred on SM 98695 01291 (Henceforth – the site). Information relating to the development has been supplied by Pembroke 21C Community Association. The proposed development **includes turning this rear burgage plot area into ‘The Journey Through Time’,** a garden designed to tell the story of Pembroke through planting and interpretation panels. A planning application has been submitted (planning application no. 15/0239/PA), the local planning authority is Pembrokeshire County Council.

Dyfed Archaeological Trust – Planning Services (Henceforth DAT-PS), in its capacity as archaeological planning advisor to Pembrokeshire County Council (Henceforth – PCC), have recommended an archaeological evaluation is undertaken at the site.

The purpose of the proposed work is to provide PCC with the information they are likely to request in respect of the proposed development, the requirements for which are set out in Planning Policy WALES, March 2002, Section 6.5, and Welsh Office Circular 60/96. The work is to highlight remains of potential archaeological interest to ensure that they are fully investigated and recorded if they are disturbed or revealed as a result of any subsequent activities associated with the development.

This Written Scheme of Investigations (WSI) has been prepared by Philip Poucher, Project Manager, Archaeology Wales Ltd (Henceforth - AW) at the request of Pembroke 21C Community Association. It provides information on the methodology which will be employed by AW during the proposed evaluation. DAT-PS have also recommended that an archaeological watching brief be maintained on any planned groundworks within the development area. This will be subject to a separate WSI that will be submitted to DAT-PS for approval on behalf of PCC.

All work will conform to the Standard and Guidance for Archaeological Evaluation (CIfA 2014) and be undertaken by suitably qualified staff and in accordance with the standards and guidelines of the IfA. The proposed work will be managed by Philip Poucher and supervised by Andrew Shobbrook.

2 Previous Results

A Desk-based Assessment of the proposed development site was undertaken by AW (Report No. 1346) for Pembroke 21C Community Association in June 2015.

The Desk-based Assessment highlighted that plot occupies a medieval burgage plot within the town of Pembroke, formerly enclosed by a defensive wall remains of which may exist below ground, along with other potential medieval deposits and

structures. Post-medieval quarrying and lime-burning activity is also present at the site, with a limekiln lying in the southern boundary wall with its structure extending into the plot. A post-medieval building has also been identified within the plot, of which there are now no above-ground remains.

There is also the potential for prehistoric remains in this area, particularly the Palaeolithic and Mesolithic within a small cave that exists within the site area, as well as general potential relating to inferred Iron Age and early medieval activity in the area.

The groundworks associated with the proposed development are anticipated to be minimal but have the potential to expose, damage and destroy archaeological remains, the extent, condition and significance of which is not yet fully understood.

3 Site specific objectives

This WSI is for a seven trench field evaluation to be undertaken within the application area in accordance with guidelines set out in Planning Policy Wales 2011 and Welsh Office Circular 60/96.

The objectives of the archaeological programme are to establish the presence or absence of archaeological deposits at the site, to assess the extent and significance of the archaeological resource of the site, to assess the potential impact of the development proposals on surviving remains, and to inform future decision making and potential mitigation strategies.

The work will include an assessment of the regional context within which the archaeological evidence rests and will aim to highlight any relevant research issues within national and regional research frameworks.

The work will result in a fully illustrated report that will provide information of sufficient detail to allow informed planning decisions to be made which can safeguard the archaeological resource. Preservation *in situ* will be advocated where at all possible, but where engineering or other factors result in loss of archaeological deposits, preservation by record will be recommended.

4 Method Statement for Evaluation

The field evaluation will comprise the excavation and recording of seven hand-excavated evaluation trenches of approximately 1.2m by 1.2m (see the attached plan), with a trench above the limekiln (Trench 5) measuring approximately 1m by 2m.

Preliminary work

The archaeological project manager in charge of the work will satisfy him/herself that all constraints to ground works have been identified, including the siting of live services, bat and badger licences and the requirement for work in the vicinity of Listed Buildings.

Evaluation

A total of seven evaluation trenches will be located across the assessment area. These trenches are located to assess features identified within the Desk-based assessment and / or areas of potential ground disturbance. The precise location of the trenches will be

agreed with DAT (with any on-site constraints taken into consideration) prior to the commencement of on-site works.

Trench 1 will be located on the upper northern terrace, located in an area away from overhanging structures in the northwest corner and the northern boundary wall. It is positioned to investigate an area identified as that of a former post-medieval building of which no above-ground remains exist. It is also in an area considered suitable for a potential medieval defensive town wall. Development plans for this area also involve the construction of a stairway from the level of the Chapel above which will require groundworks.

Trenches 2 - 4 will be located within the garden terrace plots that run down the eastern edge of the site. These will be positioned away from the boundary wall to avoid disturbing the wall, and also designed to investigate garden deposits and areas of potential best preservation, as well as attempting to ascertain original ground levels.

Trench 5 will be located across the top of the limekiln structure. This is positioned to identify the depth, condition and layout of the limekiln structure and investigate the deposits infilling the crucible of the kiln itself. The intention is to reveal the limekiln structure and clear out loose material within the crucible as part of the desire to tell the **story of Pembroke's heritage within the 'Journey Through Time', the limekiln is considered to be an significant part of the history of the site and an important feature of the 'Journey Through Time'. The Pembroke Town Walls Trust (PTWT) are also keen to promote the enhancement and preservation of the town walls, of which the kiln forms a part.** There will also be a requirement for a line of fencing to be established across the top of the southern face of the kiln and adjoining walls for safety reasons which may require groundworks in this area. Shoring will be put in place within the draw holes of the limekilns prior to any excavation work, as has been agreed in an on-site meeting with the Cadw regional building inspector, and the developers are committed to consolidating the structure as it is revealed. If the structure does become unstable during the course of the excavation then all work will cease and further advice from Cadw and DAT-PS will be sought.

Trench 6 will be located to the rear of the limekiln. This is positioned to investigate the extent of the limekiln structure and associated features, in a particular area where the establishment of footpaths may require landscaping works due to changing ground levels.

Trench 7 will be located to the east of the cave, positioned away from the overhanging stone face to the north and a badger sett to the southeast. This trench is positioned to investigate potential cave deposits. The cave itself will not be disturbed as part of the development plans, therefore it is not proposed to excavate within the cave itself, however, cave deposits may extend beyond the current limits of the cave which appears to have been altered through post-medieval quarrying activity.

All trenches will be hand-excavated to the top of the archaeological horizon by a team of professional archaeologists working alongside local community volunteers. All volunteers will work under close archaeological supervision. All areas will be hand cleaned using hoes and/or pointing trowels to prove the presence, or absence, of archaeological features and to determine their significance. In each area the excavation of the minimum number of archaeological features will be undertaken, to elucidate the character, distribution, extent and importance of the archaeological remains. This will include 50% of all linear features, 50% by half sectioning of all pit and posthole features under 1m in diameter and 50% of all larger pit features. Built structures will be cleaned but left *in situ*.

If archaeological horizons are not revealed then in each area sufficient excavation will be undertaken to ensure that the natural horizons are reached and proven. If safety reasons preclude manual excavation to natural, hand augering may be used to try to assess the total depth of stratification within each area. The depth of the excavation will conform to current safety requirements. If excavation is required below 1.2m the options of using shoring or stepped trenching will be discussed with DAT-PS.

Plans and sections will be drawn to a scale of 1:50, 1:20 and 1:10 as applicable, and these will be related to Ordnance Survey datum and published boundaries where appropriate.

Recording will be carried out using Archaeology Wales recording systems (pro-forma context sheets etc), using a continuous number sequence for all contexts in accordance with the AW technical manual – Procedures for Excavation and Site Recording 2011.

Written, drawn and photographic records of an appropriate level of detail will be maintained throughout the course of the project. Photographs will be taken in digital *RAW format, using a 14MP camera. These will be converted to Tiff format for archiving. Should significant remains be identified that require excavation, photographs will also be taken in black and white and colour slide (35mm film).

All features identified will be tied in to the OS survey grid and fixed to local **topographical boundaries and related to the developer's site plan**. The location of all features will also be recorded using a Topcon GTS725 total station.

Monitoring

DAT-PS will be contacted prior to the commencement of ground works, and subsequently once the work is underway.

DAT-PS will be provided with notice of the start date, a projected timetable and a copy of the Health and Safety Risk Assessment if required.

Any changes to the specification that the contractor may wish to make after approval will be communicated to DAT-PS for approval on behalf of the Planning Authority.

If it is felt necessary to expand on the excavation area – i.e. add further trenches or expand existing ones, this will be undertaken after discussion with DAT-PS and the client.

Representatives of DAT-PS will be given access to the site so that they may monitor the progress of the field evaluation. DAT-PS will be kept regularly informed about developments, both during the site works and subsequently during post-excavation.

Artefacts

Archaeological artefacts recovered during the course of the excavation will be cleaned and labelled using an accession number which will be obtained from the local museum. A single number sequence will be allocated to all finds. The artefacts will be stored appropriately until they are deposited with the museum.

All artefacts recovered during the project will be retained and related to the contexts from which they were derived. All typologically distinct and closely datable finds will be recorded three-dimensionally.

The evaluation will carefully consider any artefactual or economic information and provide an assessment of the viability, for further study, of such information. It will be particularly important to provide an indication of the relative significance of such material for any subsequent decision-making process regarding mitigation strategies.

Any finds which are considered to be in need of immediate conservation will be referred to a UKIC qualified conservator (Phil Parkes of Cardiff Conservation Services).

A catalogue by context of all artefactual material found, quantified by number, weight, or both, and containing sketches of significant artefacts will be compiled.

Pottery will be analysed to the standards outlined in "Guidelines for the Preparation of Pottery Archives" as prepared by the Study Group for Roman Pottery in consultation with the IFA. All other material will be analysed following the advice given in the Institute of Field Archaeologists: Guidelines for Finds Work.

The requirements for the conservation of artefacts will be unpredictable until after the completion of the fieldwork. The archaeological contractor will ensure, however, that at least minimum acceptable standards are achieved (the UK Institute of Conservation's Guidelines for the Treatment of Finds from Archaeological Site should be used as guidance).

All finds of gold and silver will be removed to a safe place and DAT-PS, the client and the local coroner informed, within the guidelines of the Treasure Act 1996.

Environmental and technological samples

Samples will be taken where necessary when significant deposits are located. Minimum sample size will be 10 litres (where possible). Where the minimum sample size is not achievable, then 100% of the deposit will be sampled.

Samples will be retained for processing. The level of post-excavation processing will be dependent on the results of the field evaluation and following discussion with an environmental specialist and DAT-PS.

Any features containing deposits of environmental or technological significance will be sampled. If required, the project manager should arrange, through a suitably qualified expert the assessment of the environmental potential of the site through examination of suitable deposits. The assessment of potential should consider the guidelines set out in the English Heritage publication 'Guidelines for Environmental Archaeology' March 2002.

The requirements for the conservation of samples will be unpredictable until after the completion of the fieldwork. The archaeological contractor will ensure, however, that at least minimum acceptable standards are achieved (the UK Institute of Conservation's Guidelines for the Treatment of Finds from Archaeological Site should be used as guidance).

Human remains

Human remains will be left in situ, covered and protected when discovered. No further investigation should normally be permitted and DAT-PS and the local Coroner must be informed immediately. After discussion, it may be appropriate to take bone samples for C14 dating. If removal is essential it can only take place under the appropriate Ministry of Justice and Environmental Health regulations.

Specialists

In the event of certain finds/features etc. being discovered, the site archaeologist may have to seek specialist opinion for assistance. Such specialists will be accessed either internally within AW itself or from an external source should any such analysis be deemed necessary. A list of specialists is given in the table below. Specialist reports will be added to the finished report as an addendum.

Type	Name	Tel No.
Flint	Amelia Pannett	02920 899509
Animal bone	Jen Kitch	07739 093712
CBM, heat affected clay, Daub etc.	Rachael Hall	01305 259751
Clay pipe	Hilary Major	01376 329316
Glass	Andy Richmond	01234 888800
Cremated and non-cremated human bone	Malin Holst	01759 368483
Metalwork	Kevin Leahy	01652 658261
Neo/BA pottery	Dr Alex Gibson	Bradford University
IA/Roman pottery	Jane Timby	01453 882851
Post Roman pottery	Mr Paul Blinkhorn	
Charcoal (wood ID)	John Carrot	01388 772167
Waterlogged wood	Nigel Nayling	University of Wales (Lampeter)
Molluscs and pollen	Dr James Rackham	01992 552256
Charred and waterlogged plant remains	Wendy Carruthers	01443 233466
Palaeoenvironmental sampling and analysis	Dr Martin Bates	University of Wales (Lampeter)

5 Method statement for the production of an illustrated report and the deposition of the site archive

Report preparation

The report will contain the following:

- **A** fully representative description of the information gained from the evaluation, even if there should be negative evidence.
- **A concise non-technical** summary of the project results.
- **At** least one plan showing the sites location in respect to the local topography, as well as the position of all excavated areas.
- Plans indicating all archaeological features. All plans and sections should be related to Ordnance Datum.
- **Written descriptions of all features and deposits excavated and their considered interpretation.**
- **A summary report on the artefactual and ecofactual assemblage and an assessment of its potential for further study, prepared by suitably qualified individuals or specialists.**
- **A statement of the local and regional context of the archaeological remains identified.**

Copies of the report will be sent to the client, DAT-PS, and for inclusion in the HER. Digital copies will be provided in pdf format if required.

A summary report of the work will be submitted for publication to a national journal (e.g. *Archaeology in Wales*) no later than one year after the completion of the post-excavation work.

The site archive

A project archive will be prepared in accordance with the National Monuments Record (Wales) agreed structure and be deposited within an appropriate local museum on completion of site analysis and report production. It will also conform to the guidelines set out in MoRPHE (English Heritage, 2006).

Arrangements will be made with the local museum before work starts. Wherever the archive is deposited, this information will be relayed to the HER.

Although there may be a period during which client confidentiality will need to be maintained, the report and the archive will be deposited not later than six months after the completion of the work.

Other significant digital data generated by the survey (i.e. AP plots, EDM surveys, CAD drawings, GIS maps, etc.) will be presented as part of the report on a CD/DVD. The format of this presented data will be agreed with the curator in advance of its preparation.

6 Resources and timetable

Standards

All stages of the project will be undertaken by AW staff using current best practice. All work will be undertaken to the standards and guidelines of the IfA.

All work will be undertaken in accordance with the AW technical manual – Procedures for Excavation and Site Recording 2011.

Staff

The project will be undertaken by suitably qualified AW staff. Overall management of the project will be undertaken by Philip Poucher.

The site will be supervised by Andrew Shobbrook.

Equipment

The project will use existing Archaeology Wales equipment.

Timetable of archaeological works

No start date has yet been set.

The site report will follow within three months of completion of the fieldwork.

Insurance

Archaeology Wales is an affiliated member of the CBA, and holds Insurance through the CBA insurance service.

Arbitration

In the event of any dispute arising out of this Agreement (including those considered as such by only one of the parties) either party may forthwith give to the other notice in writing of such a dispute or difference and the same shall be and is hereby referred for decision in accordance with the Rules of the Chartered Institute of **Arbitrators' Arbitration scheme for the Institute for Archaeologists** applying at the date of this Agreement.

Health and safety

All members of staff will adhere to the requirements of the Health & Safety at Work Act, 1974, and the Health and Safety Policy Statement of Archaeology Wales.

AW will produce a detailed Risk Assessment before any work is undertaken.



Figure 1: Location map showing site & study area. Based on Ordnance Survey 1;50,000 (@A4)

The Ordnance Survey has granted Archaeology Wales Ltd a Copyright Licence (No. 100055111) to reproduce map information; Copyright remains otherwise with the Ordnance Survey.

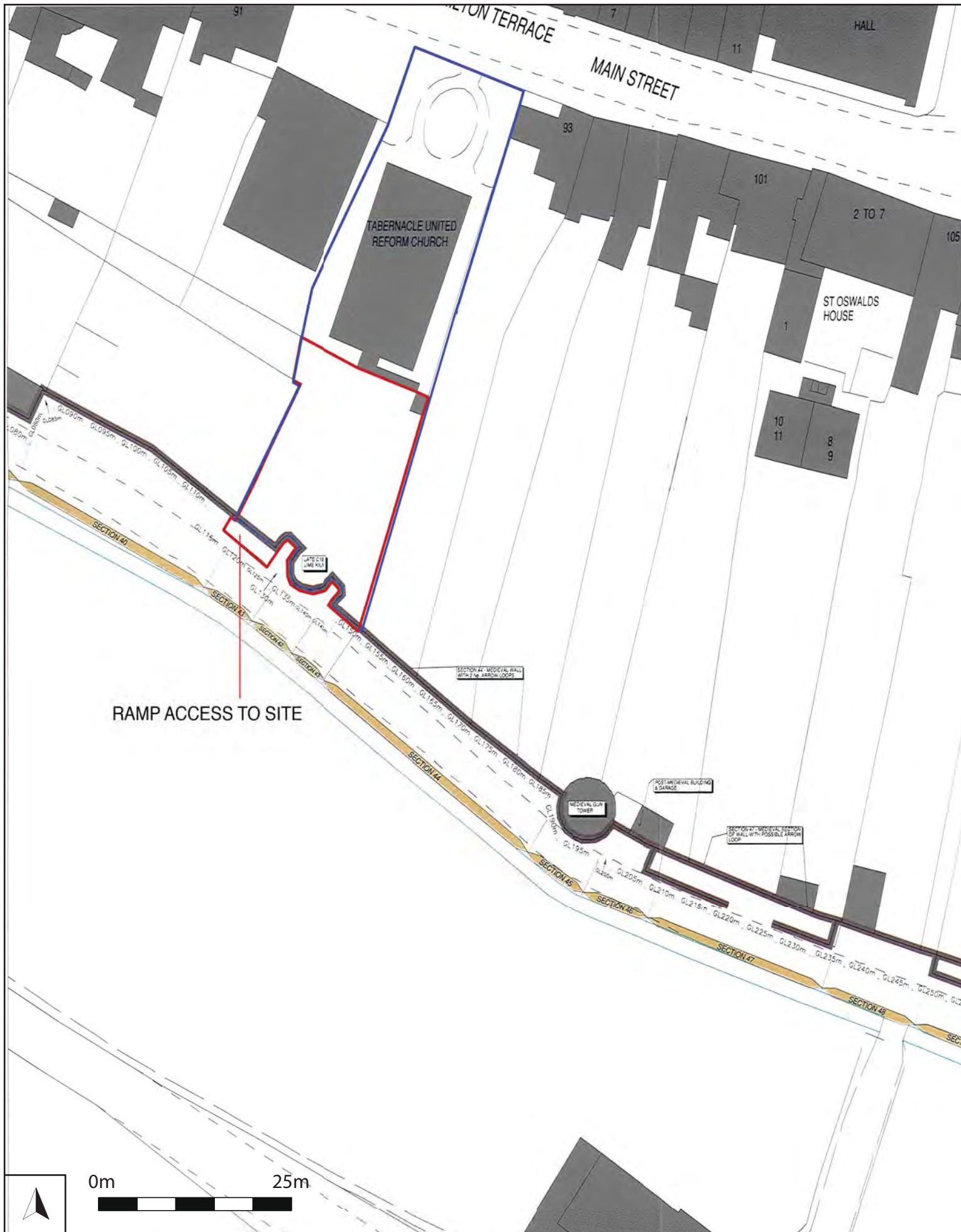

Figure 2: Site location plan. Tabernacle Church property boundary in blue, site location in red.

Plan provided by Ancanthus Holden, via Pembroke 21C.



EXISTING DRAINAGE:
FORM TIMBER CLADDING TO HIDE VERTICAL DRAINAGE

BAT:
SINGULAR LESSER HORSESHOE BAT. IVY CURTAIN TO REMAIN.

BADGER:
OUTLYING SETT IN USE

STEPS:
3 NO

GATES:
3NO WITHOUT BADGER FACILITY

GATES:
1NO WITH BADGER FACILITY

FRUIT TREES:
4NO RE-PLANTED

EXISTING ASH REMOVED

LIME KILN SOIL TO BE REMOVED FROM CRUCIBLE

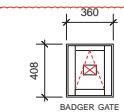
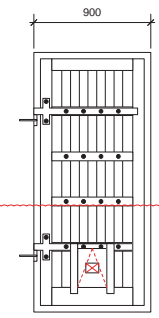
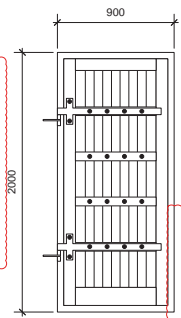

1:20

Rev	Description	Date	Initial
E	UPDATED TO SKETCH. NOTES AMENDED.	13/7/15	
D	LOGO ADDED. TREES MOVED	20/5/15	
C	TREES UPDATED	8/5/15	
B	TREES INDICATED	1/5/15	
A	NOTES ADDED. INTERNAL ARRANGEMENTS ALTERED.	13/4/15	

Energy Consultant:	
Structural Engineer:	
M & E Consultant:	
Quantity Surveyor:	

WATERMAN'S LANE
THE GREEN
PEMBROKE
PEMBROKESHIRE
WALES
SA71 4NU
TEL (01546) 685472
FAX (01546) 621200
architects@acanthusholden.co.uk
www.acanthusholden.co.uk



Client:	PTWT		
Project:	TABERNACLE WALLED GARDEN		
Drawing Title:	PLAN		
Scale:	1:100	Sheet Size:	A1
Job No:	P2009C	Drawing No:	P 100
Original:	Date:	Checked:	Approved:
	MAR 2015		E

NOTE: THESE DRAWINGS ARE TO BE READ IN CONJUNCTION WITH ALL RELATED DRAWINGS, SPECIFICATIONS AND/OR SPECIFICATIONS. ALL DISCREPANCIES TO BE CHECKED ON SITE. ANY DISCREPANCIES TO BE REPORTED IMMEDIATELY.
Copyright: Acanthus Holden Architects (Note: prints of drawing not to track scales)





Trench Location Plan

Archaeology
Wales

APPENDIX IV:
Archive Cover Sheet

ARCHIVE COVER SHEET

Tabernacle Church & Town Wall, Pembroke, Pembrokeshire

Site Name:	Tabernacle Church
Site Code:	TTWP/15/EV
PRN:	-
NPRN:	-
SAM:	-
Other Ref No:	-
NGR:	NGR SM 98695 01291
Site Type:	Medieval & Post Medieval rear burgage plot
Project Type:	Evaluation
Project Manager:	Philip Poucher
Project Dates:	September 2015 - December 2015
Categories Present:	Medieval to Modern
Location of Original Archive:	AW
Location of duplicate Archives:	Paper copies with RCAHMW, Aberystwyth with duplicate copies along with the finds at Tabernacle Chapel, Pembroke
Number of Finds Boxes:	1
Location of Finds:	To be retained by landowner for inclusion in on-site museum, Tabernacle Church, Pembroke.
Museum Reference:	TBC
Copyright:	AW
Restrictions to access:	None

Archaeology Wales

Archaeology Wales Limited

Rhos Helyg, Cwm Belan, Llanidloes, Powys SY18 6QF

Tel: +44 (0) 1686 440371

Email: admin@arch-wales.co.uk

Company Directors: Mark Houlston MIFA & Jill Houlston

Company Registered No. 7440770 (England & Wales).

Registered office: Morgan Griffiths LLP, Cross Chambers,
9 High Street, Newtown, Powys, SY16 2NY